

EUROTOOLS

TRADING

PRODUCTION

SERVICES

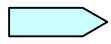

INDUSTRIAL KNIVES



ACCESSORIES

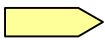

SCREENS



TOOLS FROM STOCK



MAGNETIC CLAMPINGS











SERVICES



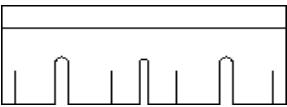

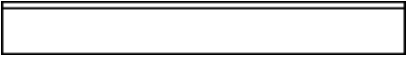
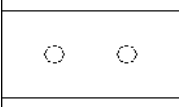

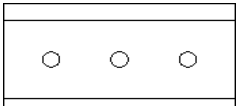
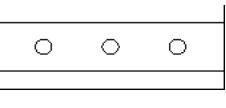

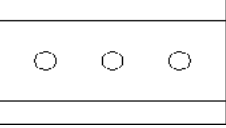
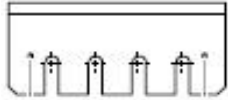

Eurotools, s.r.o.
Bagarova 2B
036 01 Martin
Slovakia, Europe

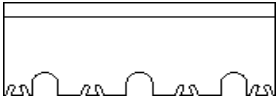
tel: 00421 43 4220262
Fax: 043 43 4220262
e mail: info@eurotools.sro.sk
WEB: www.eurotools.sro.sk

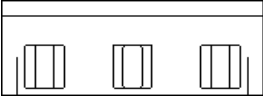
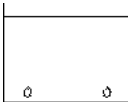

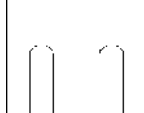
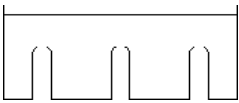
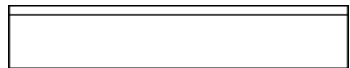
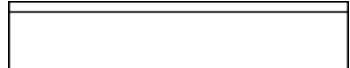

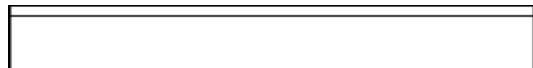
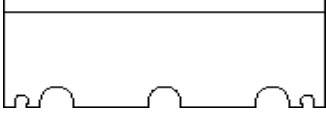

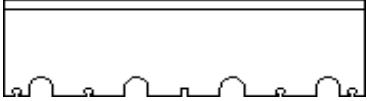

101 | Sekacie nože - Chipper knives - Hackmesser - Nože do płyt wiórowych

MANUFACTURER	CODE	SIZE mm	PLAN
ANDRITZ	101 800-225-20 AND W	800 x 225 x 20	
ANDRITZ	101 930-225-20 AND W	930 x 225 x 20	
ARI	101 296-118-16 ARI	296 x 118 x 16	
ARI	101 630-150-12 ARI	630 x 150 x 12	
ASPLUNDH / ALTEC	101 305-76.2-9.5 ASP	305 x 76.2 x 9.5	
ASPLUNDH / ALTEC	101 406-76.2-9.5 ASP	406 x 76.2 x 9.5	
BANDIT	101 127-101,6-9.5 BAN	127 x 101.6 x 9.5	
BANDIT	101 127-101,6-12,7 BAN	127 x 101.6 x 12.7	
BANDIT	101 184-101,6-9,5 BAN	184 x 101.6 x 9.5	
BANDIT	101 127-76,2-12,7 BAN	184 x 76.2 x 12.7	
BANDIT	101 184-101,6-12,7 BAN	184 x 101.6 x 12.7	
BANDIT	101 184-114-12,7 BAN	184 x 114 x 12.7	
BANGIOANI	101 247.5-110-15 BAG	247,5 x 110 x 15	

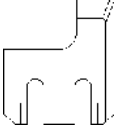
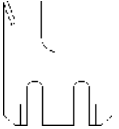

101 | Sekacie nože - Chipper knives - Hackmesser - Nože do płyt wiórowych

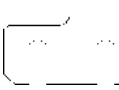
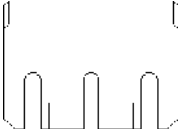
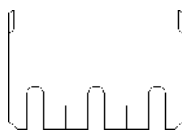
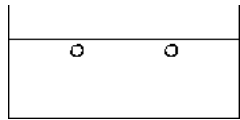
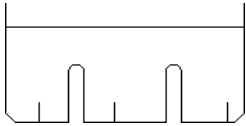
MANUFACTURER	CODE	SIZE mm	PLAN
BELOIT	101 330-127-12,7 BEL	330 x 127 x 12.7	
BELOIT	101 520-101,6-9,5 BEL	520 x 101.6 x 9.5	
BERTHRAND GARCIN	101 375-150-16 BER	375 x 150 x 16	
BEZNER	101 80-50-5 BEZ	80 x 50 x 5	
BEZNER	101 80-95-5 BEZ	80 x 95 x 5	
BEZNER	101 120-160-6 BEZ	120 x 160 x 6	
BEZNER	101 210-100-10 BEZ	210 x 100 x 10	
BISON	101 500-52-8 BIZ W	500 x 52 x 8	
BISON	101 500-55-8 BIZ W	500 x 55 x 8	
BISON	101 1020-62-8 BIZ W	1020 x 62 x 8	
BISON	101 1040-75-12 BIZ W	1040 x 75 x 12	
BLACK CLAWSON	101 380-147-12,7 BLA	380 x 147 x 12.7	
BLACK CLAWSON	101 533-127-9,5 BLA	533 x 127 x 9.5	





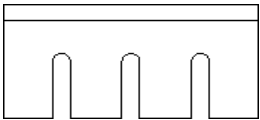
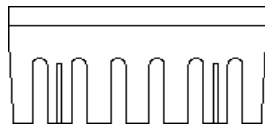
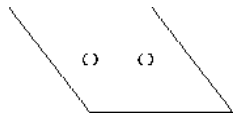
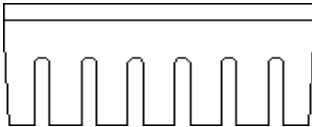
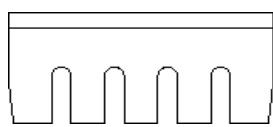
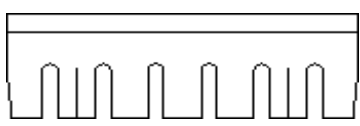
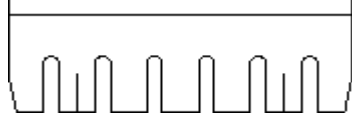
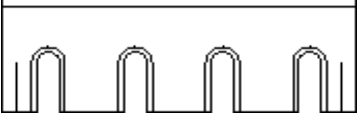
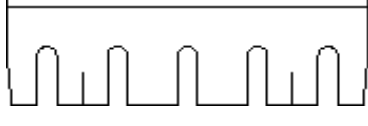
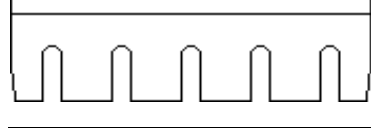
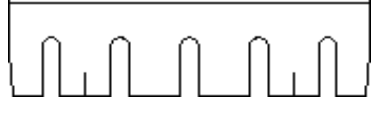
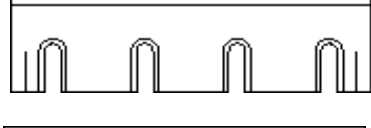

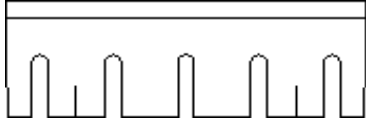

101 | Sekacie nože - Chipper knives - Hackmesser - Nože do płyt wiórowych

MANUFACTURER	CODE	SIZE mm	PLAN
BLACK CLAWSON	101 578-175-12,7 BLA	578 x 175 x 12.7	
BLACK CLAWSON	101 610-173-12,7 BLA	610x173x12.7	
BONGIANI	101 66-70-10 BON	66 x 70 x 10	
BONGIANI	101 93-120-15 BON M	93 x 120 x 15 M	
BONGIANI	101 93-120-15 BON L	93 x 120 x 15 L	
BONGIANI	101 93-120-15 BON R	93 x 120 x 15 R	
BONGIANI	101 120-125-15 BON L	120 x 125 x 15 L	
BONGIANI	101 120-125-15 BON P	120 x 125 x 15 P	
BONGIANI	101 144-120-15 BON	144 x 120 x 15	
BONGIANI	101 158-125-15 BON	158 x 125 x 15	
BRODBAECK	101 210,5-116-22 BRO	210.5 x 116 x 22	
BRODBAECK	101 210,5-118-15 BRO	210.5 x 118 x 15	
BRUCKS	101 60-54-40 BRU	60 x 54 x 40	

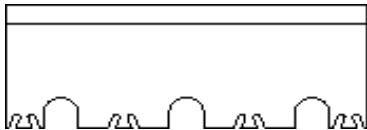

101 | Sekacie nože - Chipper knives - Hackmesser - Nože do płyt wiórowych

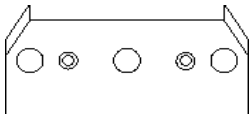
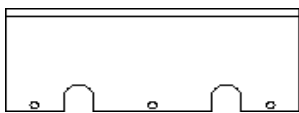
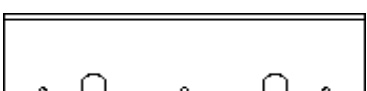
MANUFACTURER	CODE	SIZE mm	PLAN
BRUCKS	101 258-130-10 BRU	258 x 130 x 10	
BRUCKS	101 258-130-12 BRU	258 x 130 x 12	
BRUCKS	101 282-149-13 BRU	282 x 149 x 13	
BRUCKS	101 300-130-12 BRU	300 x 130 x 12	
BRUCKS	101 300-140-12 BRU	300 x 140 x 12	
BRUCKS	101 400-135-14 BRU	400 x 135 x 14	
BRUCKS	101 400-150-14 BRU	400 x 150 x 14	
BRUCKS	101 450-175-20 BRUS	450 x 175 x 20	
BRUCKS	101 465-165-16 BRU	465 x 165 x 16	
BRUCKS	101 520-170-16 BRU	520 x 170 x 16	
BRUCKS	101 525-180-16 BRU	525 x 180 x 16	
BRUCKS	101 550-175-20 BRU	550 x 175 x 20	
BRUCKS	101 575-185-15/16 BRU	575 x 185 x 15/16	





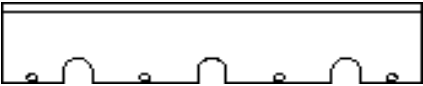
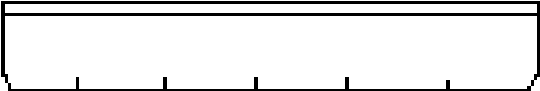
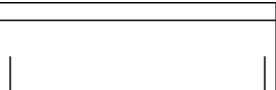
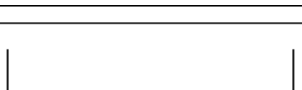

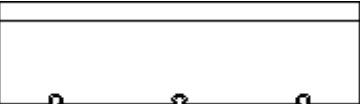
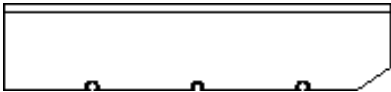
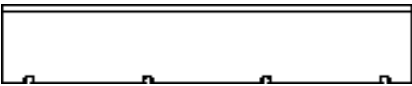
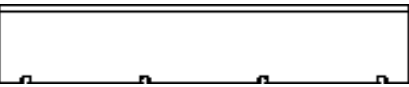
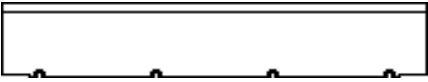
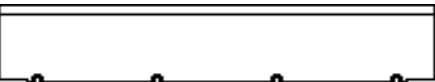
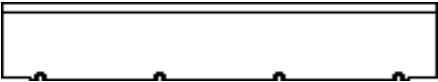
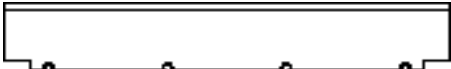

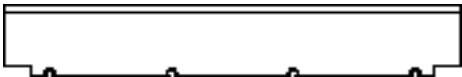

101 | Sekacie nože - Chipper knives - Hackmesser - Nože do płyt wiórowych

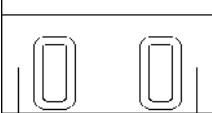
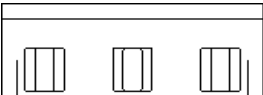
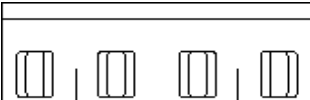
MANUFACTURER	CODE	SIZE mm	PLAN
BRUCKS	101 620-200-20 BRU	620 x 200 x 20	
BRUCKS	101 620-225-20 BRU	620 x 225 x 20	
BRUCKS	101 705-165-16 BRU	705 x 165 x 16	
BRUCKS	101 705-180-16 BRU	705 x 180 x 16	
BRUCKS	101 800-180-16 BRU	800 x 180 x 16	
BRUCKS	101 800-185-15/16 BRU	800 x 185 x 15/16	
BUSH	101 330-127-12,7 BUS	330 x 127 x 12.7	
BUSH	101 520-101,6-9,5 BUS	520 x 101.6 x 9.5	
BUSH	101 711-127-12,7 BUS	711 x 127 x 12.7	
CAE	101 250,8-125,4-12,7 CAE	250.8 x 125.4 x 12.7	
CAE	101 308-122-9,5 CAE	308 x 122 x 9.5	
CAE	101 480-122-9,5 CAE	480 x 122 x 9.5	
CAE	101 482,6-122-9,5 CAE	482.6 x 122 x 9.5	

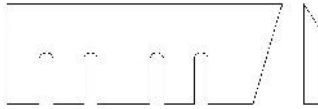



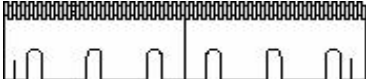

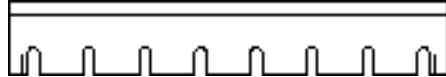

101 | Sekacie nože - Chipper knives - Hackmesser - Nože do płyt wiórowych

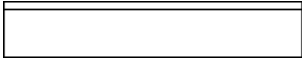
MANUFACTURER	CODE	SIZE mm	PLAN
CAE	101 560-122-9,5 CAE	560 x 122 x 9.5	
CAMURA	101 1102-141-12,7 CAM	1102 x 141 x 12,7	
CANADAC	101 275-100-12 CAN	275 x 100 x 12	
CANADAC	101 300-100-12 CAN	300 x 100 x 12	
CANADAC	101 350-100-12 CAN	350 x 100 x 12	
CARTHAGE	101 520,7-165-19 CAR	520.7 x 165 x 19	
CARTHAGE	101 609,6-152,4-12,7 CAR	609.6 x 152.4 x 12.7	
CARTHAGE	101 762-165-12,7 CAR	762 x 165 x 12.7	
CARTHAGE	101 781-152-12,7 CAR	781 x 152 x 12.7	
CARTHAGE	101 807-152-12,7 CAR	807 x 152 x 12.7	
CARTHAGE	101 830-152-12,7 CAR	830 x 152 x 12.7	
CARTHAGE	101 838-165-16 CAR	838 x 165 x 16	
CARTHAGE	101 860-152-12,7 CAR	860 x 152 x 12.7	

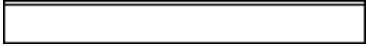

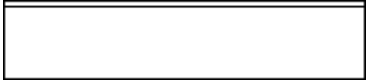

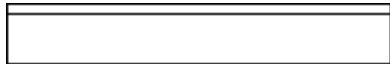
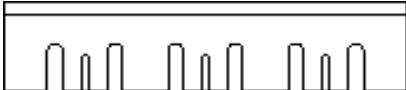

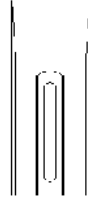
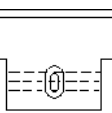
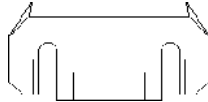
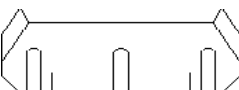
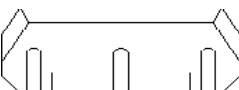

101 | Sekacie nože - Chipper knives - Hackmesser - Nože do płyt wiórowych

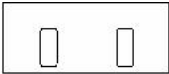
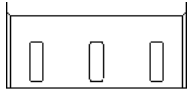
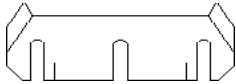
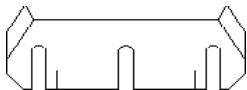
MANUFACTURER	CODE	SIZE mm	PLAN
CARTHAGE	101 882-152-12,7 CAR	882 x 152 x 12.7	
CARTHAGE	101 1011-152-12,7 CAR	1011 x 152 x 12.7	
COMACT	101 254-152-16 COM	254 x 152 x 16	
COMACT	101 338-136-16 COM	338 x 136 x 16	
COMACT	101 365-136,5-16 COM	365 x 136.5 x 16	
COMACT	101 365-136,5-16 COM2	365 x 136.5 x 16	
DMECHANIK	101 370-150-20 DME	370 x 150 x 20 mm	
DMECHANIK	101 429-85-13 DME	429 x 85 x 13 mm	
DMECHANIK	101 429-150-18 DME	429 x 150 x 18 mm	
DMECHANIK	101 430-138-18 DME	430 x 138 x 18 mm	
DMECHANIK	101 430-138-18 DME	430 x 138 x 18 mm	
DMECHANIK	101 530-114-20 DME	530 x 114 x 20 mm	
DMECHANIK	101 600-155-18 DME	600 x 155 x 18 mm	

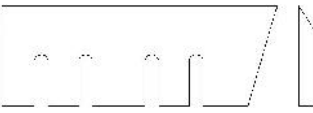
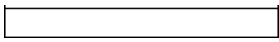

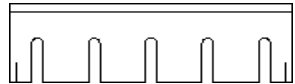

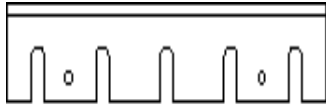
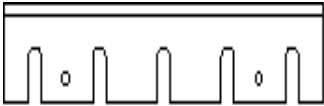

101 | Sekacie nože - Chipper knives - Hackmesser - Nože do płyt wiórowych

MANUFACTURER	CODE	SIZE mm	PLAN
ERJO	101 350-75-10 ERJ	350 x 75 x 10	
ERJO	101 450-125-11/12 ERJ	450 x 125 x 11/12	
ERJO	101 550-75-10 ERJ	550 x 75 x 10	
ERJO	101 550-125-11/12 ERJ	550 x 125 x 11/12	
ERJO	101 550-135-12 ERJ	550 x 135 x 12	
ERJO	101 665-175-15/16 ERJ	665 x 175 x 15/16	
ERJO	101 700-125-11/12 ERJ	700 x 125 x 11/12	
ERJO	101 700-175-15/16 ERJ	700 x 175 x 15/16	
ERJO	101 800-185-15/16 ERJ	800 x 185 x 15/16	 
ESTERER	101 144-52-25 EST O	144 x 52 x 25	
ESTERER	101 62-57-9,9 EST O	62 x 57 x 9,9	
ESTERER	101 200-100-12 EST	200 x 110 x 12	
ESTERER	101 289-115-12 EST C	289 x 115 x 12	



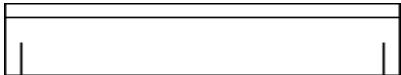
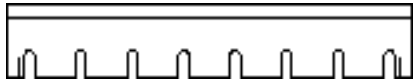
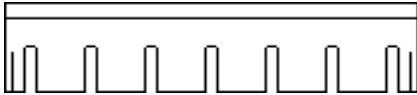
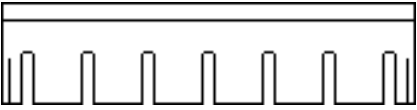

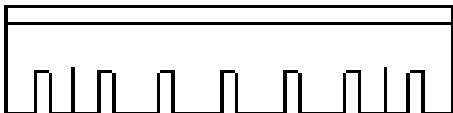
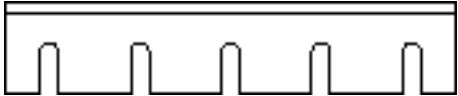
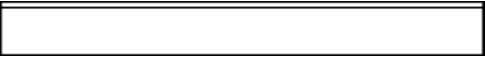





101 | Sekacie nože - Chipper knives - Hackmesser - Nože do płyt wiórowych

MANUFACTURER	CODE	SIZE mm	PLAN
EUROTOOLS	101 120-60-8 EUR C	120 x 60 x 80	
EUROTOOLS	101 280-100-10 EUR C	280 x 100 x 10	
EUROTOOLS	101 270-100-12 EUR C	270 x 100 x 12	
EUROTOOLS	101 289-115-12 EUR C	289 x 115 x 12	
EUROTOOLS	101 364-70-15 EUR E	364 x 70 x 15	
EUROTOOLS	101 375-150-20 EUR C	370 x 150 x 20 mm	
EUROTOOLS	101 390-30-15 EUR A	390 x 30 x 15	
EUROTOOLS	101 400-150-20 EUR C	400 x 150 x 20 mm	
EUROTOOLS	101 430-140-18 EUR C	430 x 140 x 18	
EUROTOOLS	101 460-95-16 EUR C	460 x 95 16 mm	
EUROTOOLS	101 484-150-22 EUR C	484 x 150 x 22 mm	
EUROTOOLS	101 487-150-22 EUR E	487 x 150 x 22 mm	
EUROTOOLS	101 490-150-20 EUR C	490 x 150 x 20 mm	

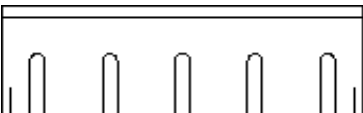

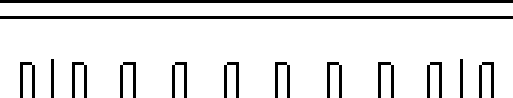

101 | Sekacie nože - Chipper knives - Hackmesser - Nože do płyt wiórowych

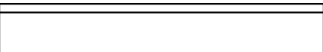
MANUFACTURER	CODE	SIZE mm	PLAN
EUROTOOLS	101 490-175-20 EUR C	490 x 175 x 20	
EUROTOOLS	101 500-125-15 EUR B	500 x 125 x 15	
EUROTOOLS	101 511-53-8 EUR C	511 x 53 x 8	
EUROTOOLS	101 540-120-20 EUR C	540 x 120 x 20	
EUROTOOLS	101 600-155-18 EUR C	600 x 155 x 18 mm	
EUROTOOLS	101 620-152-20 EUR CA	620 x 152 x 20	
EUROTOOLS	101 620-170-20 EUR C	620 x 170 x 20	
EUROTOOLS	101 665-280-25 EUR C	665 x 280 x 25	
EUROTOOLS	101 680-190-20 EUR R	680 x 190 x 20	
EUROTOOLS	101 690-150-12 EUR C	690 x 150 x 12	
EUROTOOLS	101 730-80-14 EUR C	730 x 80 x 14	
EUROTOOLS	101 760-140-20 EUR C	760 x 140 x 20	
EUROTOOLS	101 930-135-20 EUR V	950 x 120 x 10	



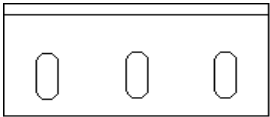
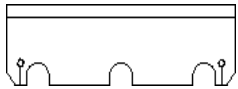
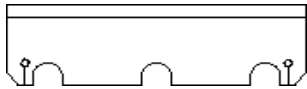

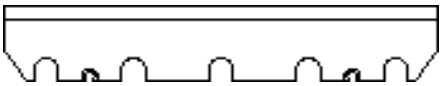
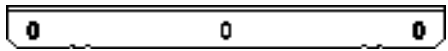
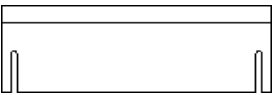
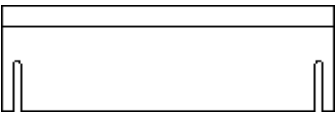
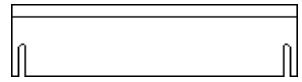

101 | Sekacie nože - Chipper knives - Hackmesser - Nože do płyt wiórowych

MANUFACTURER	CODE	SIZE mm	PLAN
EUROTOOLS	101 950-120-10 EUR C	950 x 120 x 10	
FERRARI	101 320-100-10 FER	320 x 100 x 10	
FERRARI	101 400-120-15 FER	400 x 120 x 15	
FERRARI	101 400-140-15 FER	400 x 140 x 15	
FERRARI	101 450-152-20 FER	450 x 152 x 20	
FERRARI	101 620-152-20 FER	620 x 152 x 20	
FERRARI	101 620-170-20 FER	620 x 170 x 20	
FERRARI	101 620-210-20 FER	620 x 210 x 20	
FERRARI	101 920-152-20 FER	920 x 152 x 20	
FERRARI	101 920-210-20 FER	920 x 210 x 20	
FERRARI	101 948-210-20 FER	948 x 210 x 20	
FERRARI	101 1100-250-25 FER	1100 x 250 x 25	
FICHTBURG	101 381-69,8-9,5 FIC	381 x 69.8 x 9.5	

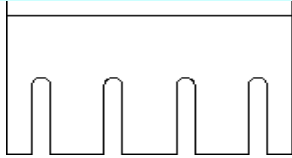
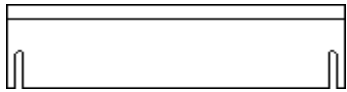

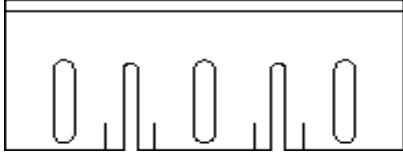
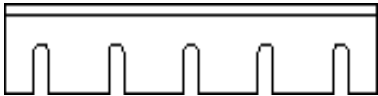
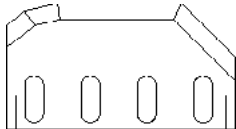
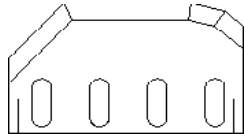
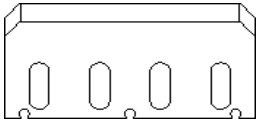
101 | Sekacie nože - Chipper knives - Hackmesser - Nože do płyt wiórowych

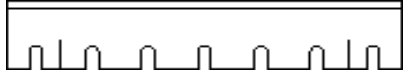
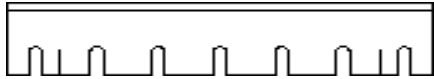
MANUFACTURER	CODE	SIZE mm	PLAN
FUJI KING	101 460-160-16 FUJ S	460 x 160 x 16	
FULGHUM	101 260-110-10 FUL	260 x 110 x 10	
FULGHUM	101 352-107-9,8 FUL	352 x 107 x 9.8	
FULGHUM	101 355-91-9,5 FUL	355 x 91 x 9.5	
FULGHUM	101 394-120-12,7 FUL	394 x 120 x 12.7	
FULGHUM	101 489-101,6-9,5 FUL	489 x 101.6 x 9.5	
FULGHUM	101 546-101,6-9,5 FUL	546 x 101.6 x 9.5	
FULGHUM	101 609-120,6-12,7 FUL	609 x 120.6 x 12.7	
FULGHUM	101 611-68,3-9,5 FUL	611 x 68.3 x 9.5	
GLOBUS	101 100-100-100 GLO	100 x 100 x 100	PICTURE
GUSTIN SOM	101 275-100-12 GUS	275 x 100 x 12	
GUSTIN SOM	101 300-100-12 GUS	300 x 100 x 12	
GUSTIN SOM	101 350-100-12 GUS	350 x 100 x 12	

101 | Sekacie nože - Chipper knives - Hackmesser - Nože do płyt wiórowych

MANUFACTURER	CODE	SIZE mm	PLAN
GUSTIN SOM	101 350-225-15 GUS	350 x 225 x 15	
GUSTIN SOM	101 400-100-12 GUS	400 x 100 x 12	
GUSTIN SOM	101 420-135-16 GUS	420 x 135 x 16	
GUSTIN SOM	101 490-230-15 GUS	490 x 230 x 15	
HEDLUND	101 452-190-16 HED	452 x 190 x 16	
HEINOLA/AHLSTROM	101 245-150-12L HEI	245 x 150 x 12	
HEINOLA/AHLSTROM	101 245-150-12R HEI	245 x 150 x 12	
HEINOLA/AHLSTROM	101 250-130-12 HEI	250 x 130 x 12	
HEINOLA/AHLSTROM	101 630-155-12 HEI	630 x 155 x 12	
HEINOLA/AHLSTROM	101 720-155-12 HEI O	720 x 155 x 12	
HEINOLA/AHLSTROM	101 800-180-12 HEI O	800 x 180 x 12	
HOLZMATIC	101 450-120-20 HOL	450 x 120 x 20	
ISLES FORGE	101 432-101,6-9,5 ISL	432 x 101.6 x 9.5	



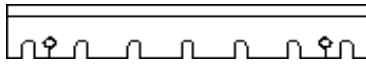
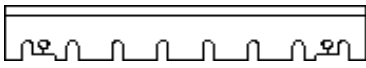
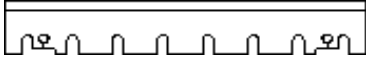
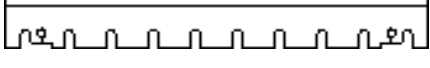
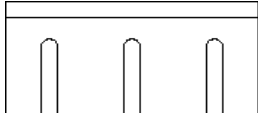
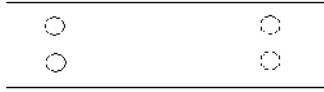
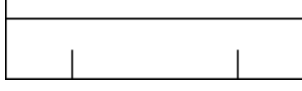
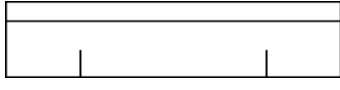
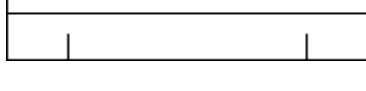
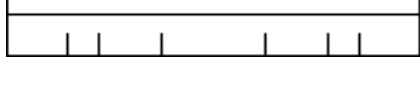
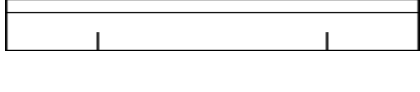
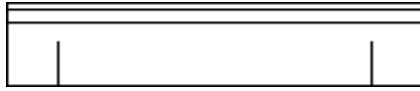







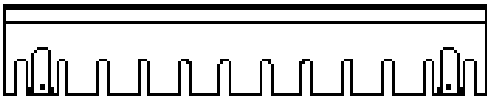
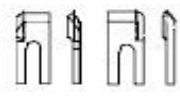

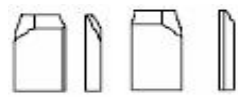
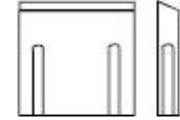
101 | Sekacie nože - Chipper knives - Hackmesser - Nože do płyt wiórowych

MANUFACTURER	CODE	SIZE mm	PLAN
ISLES FORGE	101 495,3-101,6-9,5 ISL	495.3 x 101.6 x 9.5	
ISLES FORGE	101 250-54-15 JEN	250 x 54 x 15	
JENZ	101 700-120-20 JEN	700 x 120 x 20	
JENZ	101 700-120-20 JEN2	700 x 120 x 20	
JENZ	101 820-140-20 JEN	820 x 140 x 20	
JENZ	101 1024-140-20 JEN	1024 x 140 x 20	
JUNKKARI	101 200-100-10 JUN	200 x 100 x 10	
KARHULA	101 415-115-25 KAR	415 x 115 x 25	
KLOCKNER	101 330-85-14 KLO	330 x 85 x 14	
KLOCKNER	101 428-84-14 KLO W	428 x 84 x 14	
KLOCKNER	101 430-85-14 KLO	430 x 85 x 14	
KLOCKNER	101 530-85-15 KLO	530 x 85 x 15	
KLOCKNER	101 530-85-14 KLO W	530 x 85 x 14	
KLOCKNER	101 530-120-20 KLO N,C	530 x 120 x 20	

101 | Sekacie nože - Chipper knives - Hackmesser - Nože do płyt wiórowych

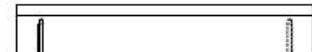
MANUFACTURER	CODE	SIZE mm	PLAN
KLOCKNER	101 530-210-20 KLO K	530 x 210 x 20	
KLOCKNER	101 565-280-25 KLO	565 x 280 x 25	
KLOCKNER	101 630-190-20 KLO	630 x 190 x 20	
KLOCKNER	101 630-210-20 KLO K	630 x 210 x 20	
KLOCKNER	101 680-120-20 KLO	680 x 120 x 20	
KLOCKNER	101 730-85-15	730 x 85 x 15	
KLOCKNER	101 830-120-20 KLO S	830 x 120 x 20	
KLOCKNER	101 830-120-20 KLO B	830 x 120 x 20	
KLOCKNER	101 830-210-20 KLO CN	830 x 210 x 20	
KLOCKNER	101 830-210-20 KLO NB	830 x 210 x 20	
KLOCKNER	101 930-120-20 KLO	930 x 120 x 20	
KLOCKNER	101 930-210-20 KLO	930 x 210 x 20	
KLOCKNER	101 930-210-20 KLO NBBu	930 x 210 x 20	
KLOCKNER	101 1130--210-20 KLO	1130 x 210 x 20	



101 | Sekacie nože - Chipper knives - Hackmesser - Nože do płyt wiórowych

MANUFACTURER	CODE	SIZE mm	PLAN
KLOCKNER	101 1330--280-25 KLO K3	1130 x 210 x 20	
KOCKUM/ESTERER	101 75-35-12,25 KOC	75 x 35 x 12.25	
KOCKUM/ESTERER	101 100-37,5-17,5 KOC	100 x 37,5 x 17,5	
KOCKUM/ESTERER	101 50-30-9,5 KOC	50 x 30 x 9.5	
KOCKUM/ESTERER	101 60-54-15 KOC	60 x 54 x 15	
KONE WOOD	101 600-225-20 KON	600 x 225 x 20	
KONE WOOD	101 800-225-20 KON	800 x 225 x 20	
KONE WOOD	101 920-225-20 KON	920 x 225 x 20	
KONE WOOD	101 1030-136-15,9 KON	1030 x 136 x 15.9	 
LBL	101 90-60-22 LBL	90 x 60 x 22	
LBL	101 105-83-22 LBL	105 x 83 x 22	
LBL	101 185-90-18 LBL	185 x 90 x 18	
LBL	101 218-100-18 LBL	218 x 100 x 18	
LBL	101 235-100-18 LBL	235 x 100 x 18	

101 | Sekacie nože - Chipper knives - Hackmesser - Nože do plyn wiórowych

MANUFACTURER	CODE	SIZE mm	PLAN
LINCK	101 105-41-8 LIN	105 x 41 x 8	
LINCK	101 105,5-10 LIN	105,6 x 50 x 10	
LINCK	101 105-92-12 LIN	105 x 92 x 12	
LINCK	101 120-90-10 LIN	120 x 90 x 10	
LINCK	101 120-95-10 LIN	LIC 120 x 95 x 10	
LINCK	101 140-95-10 LIN	LIC 140 x 95 x 10	
LINCK	101 215-152-12 LIN	LIC 215 x 152 x 12	
LINCK	101 216-152-12 LIN	LIC 216 x 152 x 12	

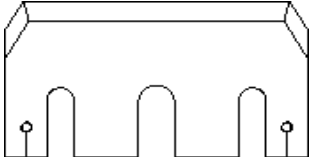
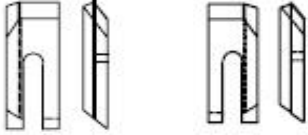
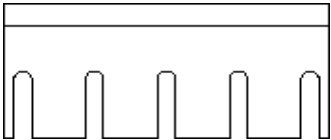
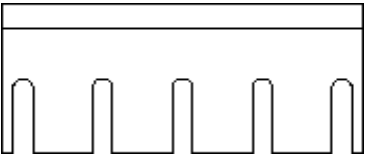
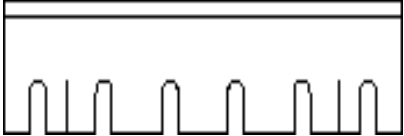
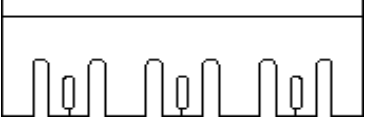
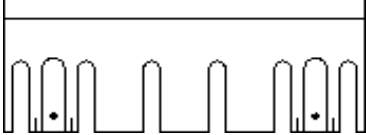
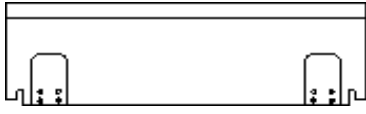









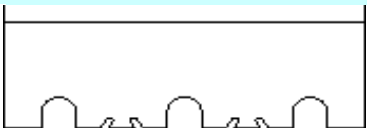

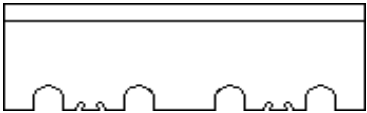
101 | Sekacie nože - Chipper knives - Hackmesser - Nože do płyt wiórowych

MANUFACTURER	CODE	SIZE mm	PLAN
LINCK	101 270-152-12 LIN	LIC 270 x 152 x 12	
LINDNER	101 100-37,5-18 LIND O	100 x 37.5 x 18	
LINDNER	101 410-190-18 LIN	410 x 190 x 18	
LINDNER	101 415-180-18 LIN	415 x 180 x 18	
LINDNER	101 510-190-18 LIN	510 x 190 x 18	
MAIER	101 640-240-20 MAI	640 x 240 x 20	
MAIER	101 665-280-25 MAI	665 x 280 x 25	
MAIER	101 815-260-25 MAI	815 x 260 x 25	
MAIER	101-840-240-20 MAI	840 x 240 x 20	

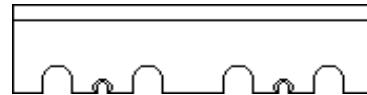

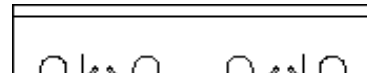

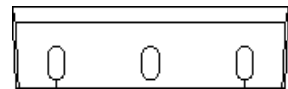
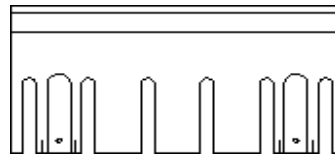
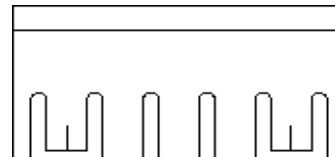

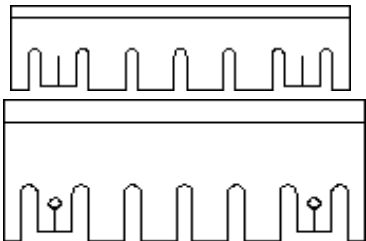

101 | Sekacie nože - Chipper knives - Hackmesser - Nože do płyt wiórowych

MANUFACTURER	CODE	SIZE mm	PLAN
MITTS	101 108-60-12,7 MIT	108 x 60 x 12.7	
MORBARK	101 152,4-108-11,1 MOR	152.4 x 108 x 11.1	
MORBARK	101 184-76,2-9,5 MOR	184 x 76.2 x 9.5	
MORBARK	101 184-101,6-9,5 MOR	184 x 101.6 x 9.5	
MORBARK	101 184-127-12,7 MOR	184 x 127 x 12.7	
MORBARK	101 203,2-127-12,7 MOR	203.2 x 127 x 12.7	
MORBARK	101 266-101,6-9,5 MOR	266 x 101.6 x 9.5	
MORBARK	101 266-106,3-12,7 MOR	266 x 106.3 x 12.7	
MORBARK	101 266-127-12,7 MOR	266 x 127 x 12.7	
MORBARK	101 292-127-12,7 MOR	292 x 127 x 12.7	
MORBARK	101 317-76,5-9,5 MOR	317 x 76.5 x 9.5	

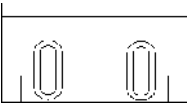
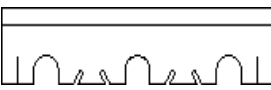
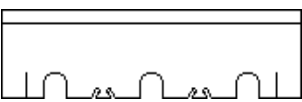
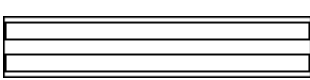
101 | Sekacie nože - Chipper knives - Hackmesser - Nože do płyt wiórowych

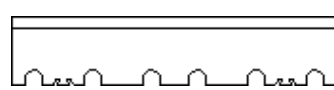
MANUFACTURER	CODE	SIZE mm	PLAN
MORBARK	101 330-127-12,7 MOR	330 x 127 x 12.7	
MORBARK	101 374-101,6-9,5 MOR	374 x 101.6 x 9.5	
MORBARK	101 381-127-12,7 MOR	381 x 127 x 12.7	
MORBARK	101 497-101,7-12,7 MOR	497 x 101.7 x 12.7	
MORBARK	101 584-127-12,7 MOR	584 x 127 x 12.7	
NICOLSON	101 322-108-12,7 NIC	322 x 108 x 12.7	
NICOLSON	101 393,6-108-12,7 NIC	393.6 x 108 x 12.7	
NICOLSON	101 394-76-4,7 NIC	394 x 76 x 4.7	
NICOLSON	101 457-101,6-9,5 NIC	457 x 101.6 x 9.5	
OLATHE	101 305-50,8-4,75 OLA	305 x 50.8 x 4.75	
PALLMANN	101 350-100-20 PAL	350 x 100 x 20	
PALLMANN	101 565-280-25 PAL	565 x 280 x 25	
PALLMANN	101 565-295-25 PAL	565 x 295 x 25	
PALLMANN	101 630-130-12 PAL	630 x 130 x 12	









101 | Sekacie nože - Chipper knives - Hackmesser - Nože do płyt wiórowych

MANUFACTURER	CODE	SIZE mm	PLAN
PALLMANN	101 630-160-15 PAL	630 x 160 x 15	
PALLMANN	101 665-295-25 PAL	665 x 295 x 25	
PALLMANN	101 780-220-20 PAL	780 x 220 x 20	
PALLMANN	101 880-180-16 PAL	880 x 180 x 16	
PHL	101 254-152-PHL	254 x 152 x 16	
PRECISION	101 317,5-76-9,5 PRE	317.5 x 76 x 9.5	
PRECISION	101 375-102-9,5 PRE	375 x 102 x 9.5	
PRECISION	101 400-76,2-25,4 PRE	400 x 76.2 x 25.4	
PRECISION	101 498-101,6-9,5 PRE	498 x 101.6 x 9.5	
PRECISION	101 546-101,6-9,5 PRE	546 x 101.6 x 9.5	
PRECISION	101 584-127-12,7 PRE	584 x 127 x 12.7	
PRECISION	101 660-127-12,5 PRE	660 x 127 x 12.5	
PRECISION	101 711-127-12,7 PRE	711 x 127 x 12.7	
RAUMA	101 817-141-12,7 RAUS	817 x 141 x 12.7	

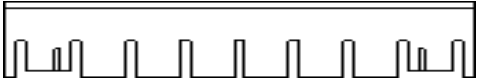
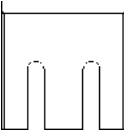
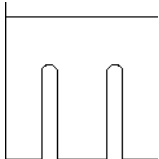
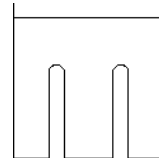
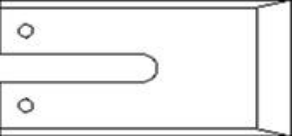
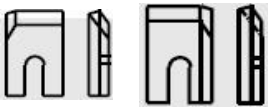



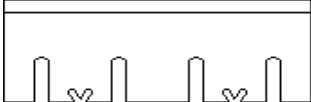

101 | Sekacie nože - Chipper knives - Hackmesser - Nože do pływ wiórowych

MANUFACTURER	CODE	SIZE mm	PLAN
RAUMA	101 917-145-16 RAU	917 x 145 x 16	
RAUMA	101 917-160-16 RAU	917 x 160 x 16	
RAUMA	101 939-152-12,7 RAU	939 x 152 x 12.7	
RAUMA	101 1030-136-15,9 RAU	1030 x 136 x 15.9	
RUDNICK ENNERS	101 390-160-15 RUD	390 x 160 x 15	
RUDNICK ENNERS	101 430-130-12 RUD	430 x 130 x 12	
RUDNICK ENNERS	101 530-130-12 RUD	530 x 130 x 12	
RUDNICK ENNERS	101 530-160-15 RUD	530 x 160 x 15	
RUDNICK ENNERS	101 630-130-12 RUD	630 x 130 x 12	
RUDNICK ENNERS	101 630-160-15 RUD	630 x 160 x 15	
RUDNICK ENNERS	101 630-220-20 RUD	630 x 220 x 20	
RUDNICK ENNERS	101 680-130-12 RUD	680 x 130 x 12	
RUDNICK ENNERS	101 780-155-15 RUD O	780 x 155 15	
RUDNICK ENNERS	101 780-160-15 RUD	780 x 160 x 15	
RUDNICK ENNERS	101 780-220-20 RUD	780 x 220 x 20	

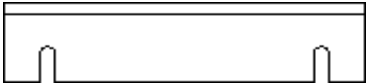

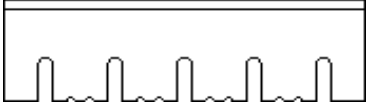
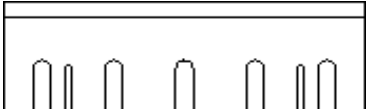
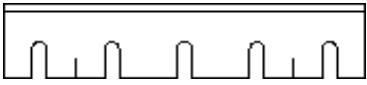

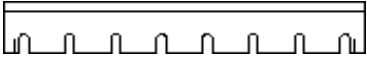
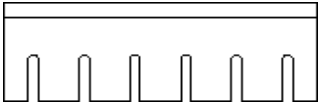
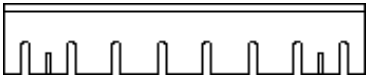
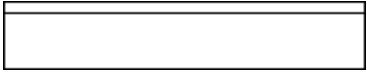
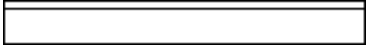

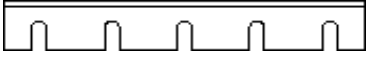
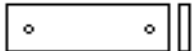



101 | Sekacie nože - Chipper knives - Hackmesser - Nože do płyt wiórowych

MANUFACTURER	CODE	SIZE mm	PLAN
RUDNICK ENNERS	101 805-205-20 RUD K3	805 x 205 x 20	
RUDNICK ENNERS	101 1330-280-25 RUD K3	1330 x 280 x 25	
RUDNICK ENNERS	101 1800-190-36 RUD K3	1800 x 190 x 36	
SAWQUIP	101 140-165-9,5 SAW O	140 x 165 x 9.5	
SAWQUIP	101 164-140-9,5 SAW O	164 x 140 x 9.5	
SAWQUIP	101 163,14-139,7-9,3 SAW	163.14 x 139.7 x 9.3	
SAWQUIP	101 165-88-9,5 SAW	165 x 88 x 9.5	
SEGEM	101 65-45-14 SEG	65 x 40 x 14	
SEGEM	101 235-150-8 SEG	235 x 150 x 8	
SEGEM	101 235-150-8 SEG2	235 x 150 x 8	
SEGEM	101 335-150-8 SEG	335 x 150 x 8	
SEGEM	101 360-135-12 SEG	360 x 135 x 12	
SEGEM	101 360-135-12 SEG2	360 x 135 x 12	

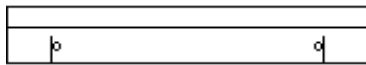
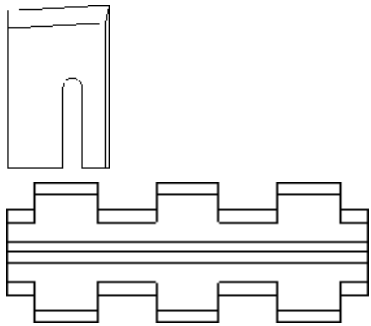
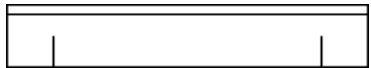
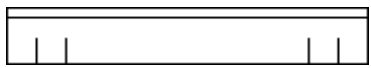
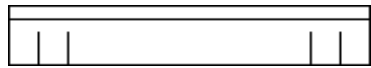

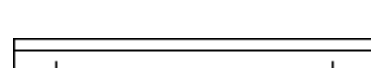





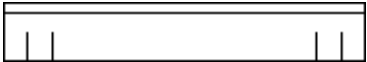

101 | Sekacie nože - Chipper knives - Hackmesser - Nože do płyt wiórowych

MANUFACTURER	CODE	SIZE mm	PLAN
SEGEM	101 440-110-12 SEG	440 x 110 x 12	
SEGEM	101 450-120-20 SEG	450 x 120 x 20	
SEGEM	101 470-150-12 SEG	470 x 150 x 12	
SEGEM	101 470-160-16 SEG	470 x 160 x 16	
SEGEM	101 650-150-12 SEG	650 x 150 x 12	
SEGEM	101 650-150-16 SEG	650 x 150 x 16	
SEGEM	101 840-160-12 SEG	840 x 160 x 12	
SEGEM	101 910-150-12 SEG	910 x 150 x 12	
SIBA / ABC	101 465-165-16 SIB	465 x 165 x 16	
SIBA / ABC	101 800-175-15/16 SIB	800 x 175 x 15/16	
SJÖLINS	101 350-75-10 SJO	350 x 75 x 10	
SJÖLINS	101 550-75-10 SJO	550 x 75 x 10	
SJÖLINS	101 550-110-10 SJO	550 x 110 x 10	
SJÖLINS	101 700-110-10 SJO	700 x 110 x 10	
SKORPION	101 175-80-14,5 SKO W	175 x 80 x 14,5	

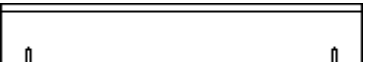
101 | Sekacie nože - Chipper knives - Hackmesser - Nože do płyt wiórowych

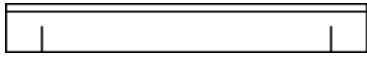
MANUFACTURER	CODE	SIZE mm	PLAN
SKORPION	101 185-98-14 SKO W	185 x 98 x 14	
SPRINGER	101 720-210-20 SPR CS	720 x 210 x 20	
SODERHAMM	101 330-127-12,7 SOD	330 x 127 x 12.7	
SODERHAMM	101 711-127-12,7 SOD	711 x 127 x 12.7	
SZT	101 430-85-14 SZT	430 x 85 x 14	
TOMAHAWK	101 260-110-14 TOM B	260 x 110 x 14	
VECOPLAN	101 174-75-25 VEC	174 x 75 x 25	
VECOPLAN	101 349-70-10 VEC	349 x 70 x 10	
VECOPLAN	101 480-85-10 VEC	480 x 85 x 10	
VECOPLAN	101 480-90-14 VEC	480 x 90 x 14	
VECOPLAN	101 480-120-14 VEC	480 x 120 x 14	
VECOPLAN	101 530-85-14 VEC	530 x 85 x 14	
VECOPLAN	101 580-85-10 VEC	580 x 85 x 10	
VECOPLAN	101 580-90-14 VEC	580 x 90 x 14	

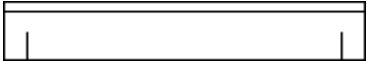
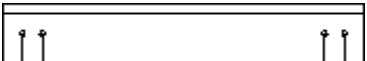

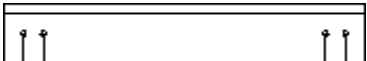
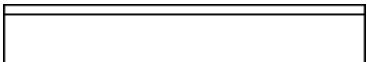
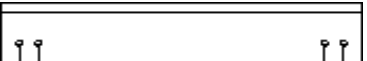
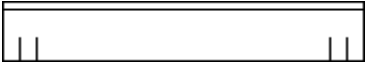



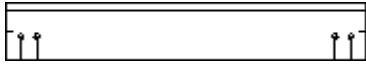
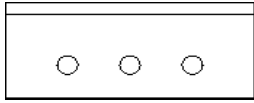
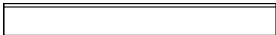
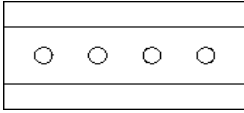
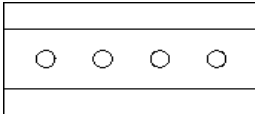
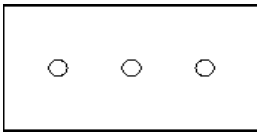
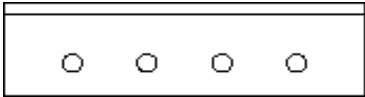
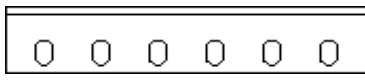
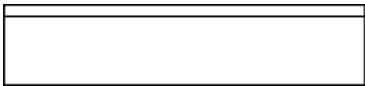
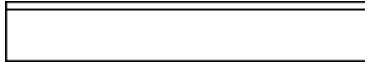
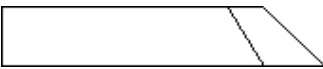
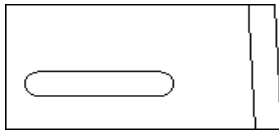
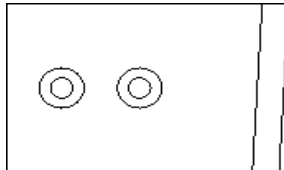

101 | Sekacie nože - Chipper knives - Hackmesser - Nože do płyt wiórowych

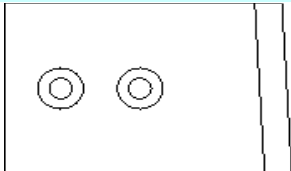
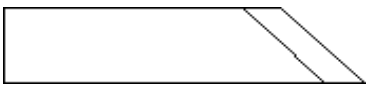
MANUFACTURER	CODE	SIZE mm	PLAN
VECOPLAN	101 580-100-14 VEC	580 x 100 x 14	
VECOPLAN	101 580-120-14 VEC	580 x 120 x 14	
VECOPLAN	101 680-90-14 VEC	680 x 90 x 14	
VECOPLAN	101 680-120-14 VEC	680 x 120 x 14	
VECOPLAN	101 680-160-20 VEC	680 x 160 x 20	
VECOPLAN	101 680-180-25 VEC	680 x 180 x 25	
VECOPLAN	101 780-120-14 VEC	780 x 120 x 14	
VECOPLAN	101 780-160-20 VEC	780 x 160 x 20	
VECOPLAN	101 880-160-20 VEC	880 x 160 x 20	
VECOPLAN	101 880-200-25 VEC	880 x 200 x 25	
VECOPLAN	101 980-85-10 VEC	980 x 85 x 10	
VECOPLAN	101 1080-200-25 VEC	1080 x 200 x 25	
VECOPLAN	101 1085-240-25	1085 x 240 x 25	
VECOPLAN	101 1130-240-25 VEC	1130 x 240 x 25	
VECOPLAN	101 1280-240-25 VEC	1280 x 240 x 25	

101 | Sekacie nože - Chipper knives - Hackmesser - Nože do płyt wiórowych

MANUFACTURER	CODE	SIZE mm	PLAN
VECOPLAN	101 1350-240-25 VEC	1350 x 240 x 25	
VERMEER	101 203-89-9,5 VER	203 x 89 x 9.5	
VERMEER	101 210-25,4-6 VER	210 x 25,4 x 6	
VERMEER	101 228-114-15,9 VER	228 x 114 x 15.9	
VERMEER	101 250-127-13 VER	250 x 127 x 13	
VERMEER	101 267-152-19 VER	267 x 152 x 19	
VERMEER	101 308-89-9,5 VER	308 x 89 x 9.5	
VERMEER	101 404,6-84,2-9,5 VER	404.6 x 84.2 x 9.5	
WAYNE	101 305-76,2-9,5 WAY	305 x 76.2 x 9.5	
WAYNE	101 406-76-9,5 WAY	406 x 76 x 9.5	
WEMA PROBST	101 115-23-8 WEM	23 x 115 x 8	
WEMA PROBST	101 125-63-8 WEM C	125 x 63 x 8	
WEMA PROBST	101 127-85-10L WEM	127 x 85 x 10	

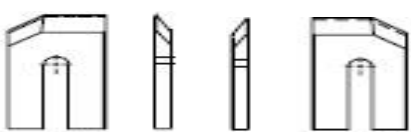
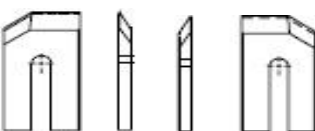
101 | Sekacie nože - Chipper knives - Hackmesser - Nože do pływ wiórowych

MANUFACTURER	CODE	SIZE mm	PLAN
WEMA PROBST	101 127-85-10R WEM	127 x 85 x 10	
WEMA PROBST	101 200-20-10 WEM B	200 x 20 x 10	
WEMA PROBST	101 139-33-10 WEM	139 x 33 x 10	
WIGGER	101 700-200-20 WIG	700 x 200 x 20	
WURSTER & DEITZ	101 140-70-12 WUR O	75 x 35 x 12,5	
WURSTER & DEITZ	101 75-35-12 EUR C	75 x 35 x 12	
WURSTER & DEITZ	101 100-37,5-17,5 EUR C	100 x 37,5 x 17,5	
WURSTER & DEITZ	101 140-70-12 WUR	140 x 70 x 12	
WURSTER & DEITZ	101 140-35-17 EUR C	140 x 35 x 17	
WURSTER & DEITZ	101 140-35-18 EUR C	140 x 35 x 18	
ZENO	101 515-140-20 ZEN O	515 x 140 x 20	

102 Hobľovacie nože - planing knives - Streifenhobelmesser - Nože do strugarek

Materiall: HSS 18% W, HSS 6% W, 1.3355, 1.3343, 1.2379, T1, M2, D2

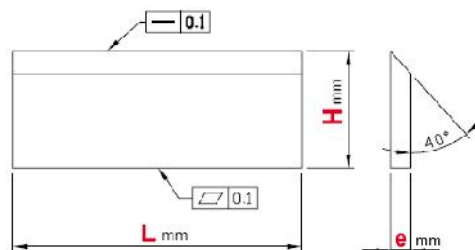

L x H x e (mm)

60x35x3.0	60x30x3.0	60x25x3.0	60x20x3.0	60x25x2.5	60x20x2.5
80x35x3.0	80x30x3.0	80x25x3.0	80x20x3.0	80x25x2.5	80x20x2.5
100x35x3.0	100x30x3.0	100x25x3.0	100x20x3.0	100x25x2.5	100x20x2.5
120x35x3.0	120x30x3.0	120x25x3.0	120x20x3.0	120x25x2.5	120x20x2.5
130x35x3.0	130x30x3.0	130x25x3.0	130x20x3.0	130x25x2.5	130x20x2.5
150x35x3.0	150x30x3.0	150x25x3.0	150x20x3.0	150x25x2.5	150x20x2.5
160x35x3.0	160x30x3.0	160x25x3.0	160x20x3.0	160x25x2.5	160x20x2.5
170x35x3.0	170x30x3.0	170x25x3.0	170x20x3.0	170x25x2.5	170x20x2.5
180x35x3.0	180x30x3.0	180x25x3.0	180x20x3.0	180x25x2.5	180x20x2.5
210x35x3.0	210x30x3.0	210x25x3.0	210x20x3.0	210x25x2.5	210x20x2.5
230x35x3.0	230x30x3.0	230x25x3.0	230x20x3.0	230x25x2.5	230x20x2.5
240x35x3.0	240x30x3.0	240x25x3.0	240x20x3.0	240x25x2.5	240x20x2.5
250x35x3.0	250x30x3.0	250x25x3.0	250x20x3.0	250x25x2.5	250x20x2.5
260x35x3.0	260x30x3.0	260x25x3.0	260x20x3.0	260x25x2.5	260x20x2.5
300x35x3.0	300x30x3.0	300x25x3.0	300x20x3.0	300x25x2.5	300x20x2.5
310x35x3.0	310x30x3.0	310x25x3.0	310x20x3.0	310x25x2.5	310x20x2.5
350x35x3.0	350x30x3.0	350x35x3.0	350x20x3.0	350x25x2.5	350x20x2.5
400x35x3.0	400x30x3.0	400x25x3.0	400x20x3.0	400x25x2.5	400x20x2.5
410x35x3.0	410x30x3.0	410x25x3.0	410x20x3.0	410x25x2.5	410x20x2.5
450x35x3.0	450x30x3.0	450x25x3.0	450x20x3.0	450x25x2.5	450x20x2.5
500x35x3.0	500x30x3.0	500x25x3.0	500x20x3.0	500x25x2.5	500x20x2.5
510x35x3.0	510x30x3.0	510x25x3.0	510x20x3.0	510x25x2.5	510x20x2.5
530x35x3.0	530x30x3.0	530x25x3.0	530x20x3.0	530x25x2.5	530x20x2.5
600x35x3.0	600x30x3.0	600x25x3.0	600x20x3.0	600x25x2.5	600x20x2.5
610x35x3.0	610x30x3.0	610x25x3.0	610x20x3.0	610x25x2.5	610x20x2.5
640x35x3.0	640x30x3.0	640x25x3.0	640x20x3.0	640x25x2.5	640x20x2.5
710x35x3.0	710x30x3.0	710x25x3.0	710x20x3.0	710x25x2.5	710x20x2.5
810x35x3.0	810x30x3.0	810x25x3.0	810x20x3.0	810x25x2.5	810x20x2.5
910x35x3.0	910x30x3.0	910x25x3.0	910x20x3.0	910x25x2.5	910x20x2.5
1000x35x3.0	1000x30x3.0	1000x25x3.0	1000x20x3.0	1000x25x2.5	1000x20x2.5
1010x35x3.0	1010x30x3.0	1010x25x3.0	1010x20x3.0	1010x25x2.5	1010x20x2.5
1050x35x3.0	1050x30x3.0	1050x25x3.0	1050x20x3.0	1050x25x2.5	1050x20x2.5
1220x35x3.0	1220x30x3.0	1220x25x3.0	1220x20x3.0	1220x25x2.5	1220x20x2.5

Eurotools, s.r.o.
Bagarova 2B
036 01 Martin
Slovakia, Europe











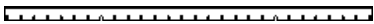

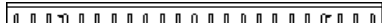

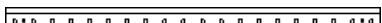

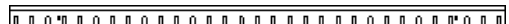
tel: 00421 43 4220262
Fax: 043 43 4220262
e mail: info@eurotools.sro.sk
WEB: www.eurotools.sro.sk

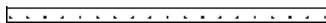





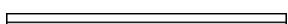

103 Nože na dýhu - Veneer knives - Furniermesser - Nože do plyn fornirowanych

MANUFACTURER	CODE	SIZE mm	PLAN
BSH	103 1930-180-16 BSH W	1930 x 180 x 16	
COE	103 100-100-100 COE	100 x 100 x 100	
CORALI	103 900-140-12 COR	900 x 140 x 12	
CORALI	103 900-155-16 COR	900 x 155 x 16	
CORALI	103 900-175-15 COR B	900 x 170 x 15	
CREMONA	103 1200-180-15 CRE	1200 x 180 x 15	
CREMONA	103 1240-180-15 CRE	1240 x 180 x 15	
CREMONA	103 1250-200-15 CRE	1250 x 200 x 15	
CREMONA	103 1350-100-10 CRE	1350 x 100 x 10	
CREMONA	103 1690-190-16 CRE	1690 x 190 x 16	
CREMONA	103 1700-100-10 CRE	1700 x 100 x 10	
CREMONA	103 1700-190-16 CRE	1700 x 190 x 16	
CREMONA	103 1750-120-6 CRE	1750 x 120 x 6	
CREMONA	103 1778-190-15 CRE	1778 x 190 x 15	
CREMONA	103 2050-180-15 CRE W	2050 x 180 x 15	
CREMONA	103 2160-180-15 CRE	2160 x 180 x 15	
CREMONA	103 2196-84-10 CRE	2196 x 84 x 10	
CREMONA	103 2740-190-16 CRE D	2740 x 190 x 16	

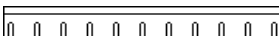

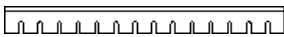
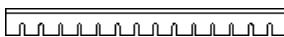
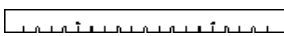

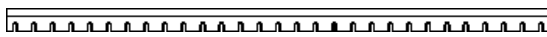
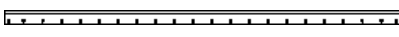
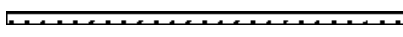
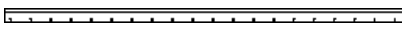
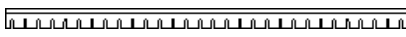
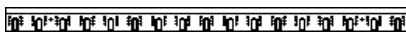
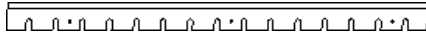
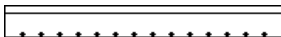
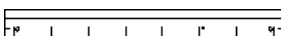

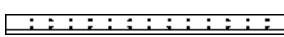
103 Nože na dýhu - Veneer knives - Furniermesser - Nože do plynit fornirowanych

MANUFACTURER	CODE	SIZE mm	PLAN
CREMONA	103 2750-120-6 CRE	2750 x 120 x 6	
CREMONA	103 2760-200-16 CRE	2760 x 200 x 16	
CREMONA	103 2800-180-15 CRE	2800 x 180 x 15	
CREMONA	103 2800-190-16 CRE	2800 x 190 x 16	
CREMONA	103 2800-190-18 CRE	2800 x 190 x 18	
DEROULEUSE	103 2666-170-15 DEE	2666 x 170 x 15	
DEROULEUSE	103 3700-170-15 DER	3700 x 170 x 15	
DERULOR	103 2380-180-15 DER	2380 x 180 x 15	
DERULOR	103 2397-175-15 DEL	2397 x 175 x 15	
DERULOR	103 2400-150-15 DEL	2400 x 150 x 15	
DERULOR	103 2400-180-18 DEL	2400 x 180 x 18	
DERULOR	103 2450-140-14 DER	2450 x 140 x 14	
DERULOR	103 2600-180-15 DER	2600 x 180 x 15	
DERULOR	103 2700-180-15 DER	2740 x 180 x 15	
EUROTOOLS	103 1397-160-13,75 EUR W	1397 x 160 x 13,75	
EUROTOOLS	103 1397-180-15 EUR	1397 x 180 x 15	
EUROTOOLS	103 1430-135-12EUR W	1430 x 135 x 12	
EUROTOOLS	103 1500-175-15 EUR B	1500 x 175 x 15	

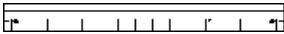
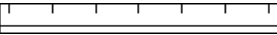

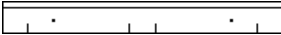

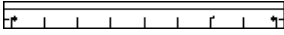
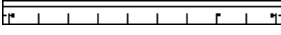
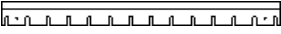
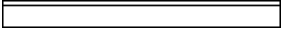
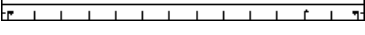
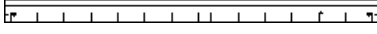
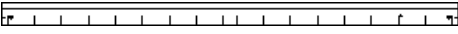
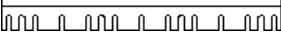
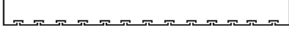

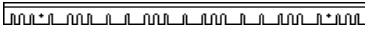
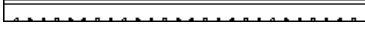
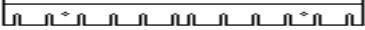



103 Nože na dýhu - Veneer knives - Furniermesser - Nože do plyn fornirowanych

MANUFACTURER	CODE	SIZE mm	PLAN
EUROTOOLS	103 1500-180-15 EUR	1500 x 180 x 15	
EUROTOOLS	103 1700-180-16 EUR B	1700 x 180 x 16	
EUROTOOLS	103 1800-125-12 EUR W	1800 x 125 x 12	
EUROTOOLS	103 2082-190-15 EUR	2082 x 190 x 15	
EUROTOOLS	103 2082-200-15 EUR	2082 x 200 x 15	
EUROTOOLS	103 2100-200-16 EUR	2100 x 200 x 16	
EUROTOOLS	103 2790-70-18 EUR W	2790 x 70 x 18	
EUROTOOLS	103 4045-180-18 EUR B	4045 x 180 x 18	
JOSTING	103 2950-120-12 JOS	2950 x 120 x 12	
JOSTING	103 2970-100-10 JOS	2970 x 100 x 10	
JOSTING	103 2975-105-10 JOS	2975 x 105 x 10	
JOSTING	103 3000-160-15 JOS	3000 x 160 x 15	
JOSTING	103 3000-200-22 JOS	3000 x 200 x 22	
JOSTING	103 3146-235-15 JOS	3146 x 235 x 15	
KELLER	103 1500-180-16 KEL N	1500 x 180 x 16	
KELLER	103 1500-180-18 KEL	1500 x 180 x 18	
KELLER	103 2700-180-16 KEL N	2700 x 180 x 16	
KELLER	103 1577-120-12 KEL	1577 x 120 x 12	



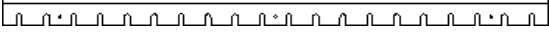
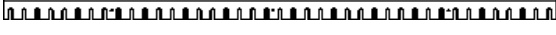

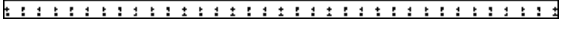
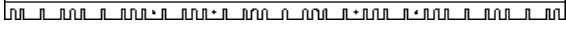
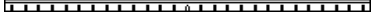
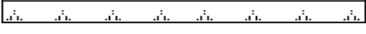
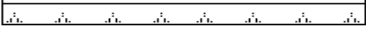
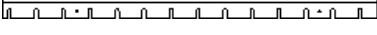
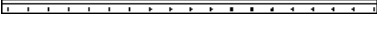

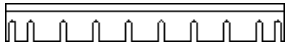
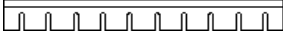

103 Nože na dýhu - Veneer knives - Furniermesser - Nože do płyt fornirowanych

MANUFACTURER	CODE	SIZE mm	PLAN
KELLER	103 1600-180-18 KEL	1600 x 180 x 18	
KELLER	103 1610-190-16 KEL	1610 x 190 x 16	
KELLER	103 1620-120-6 KEL	1620 x 120 x 6	
KELLER	103 1650-200-16 KEL	1650 x 200 x 16	
KELLER	103 2700-180-18 KEL N	2700 x 180 x 18	
KELLER	103 1700-180-18 KEL	1700 x 180 x 18	
KELLER	103 1900-180-18 KEL	1900 x 180 x 18	
KELLER	103 1900-180-20 KEL	1900 x 180 x 20	
KELLER	103 1981-200-15 KEL	1981 x 200 x 15	
KELLER	103 2700-180-18 KEL N	2700 x 180 x 18	
KELLER	103 2800-180-18 KEL	2800 x 180 x 18	
KELLER	103 3400-180-18 KEL	3400 x 180 x 18	
KPS	103 1500-180-15 KPS	1500 x 180 x 15	
KPS	103 1500-65-13 KPS B	1500 x 65 x 13	
KPS	103 2700-155-15 KPS	2700 x 155 x 15	
KPS	103 2700-180-15 KPS	2700 x 180 x 15	
KPS	103 2700-180-16 KPS	2700 x 180 x 16	
KUPER	103 100-100-100 KUP	100	

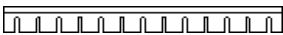
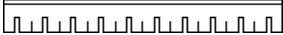
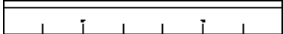
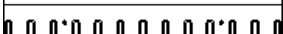
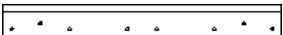
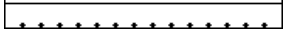
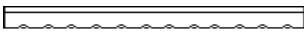
103 Nože na dýhu - Veneer knives - Furniermesser - Nože do płyt fornirowanych

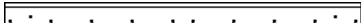
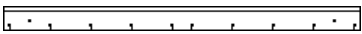
MANUFACTURER	CODE	SIZE mm	PLAN
MONGUZI	103 2850-120-12 MON	2850 x 120 x 12	
MONGUZI	103 2850-180-19 MON	2850 x 180 x 19	
MONGUZI	103 2854-72-10 MON	2854 x 72 x 10	
MONGUZI	103 3150-120-12 MON	3150 x 120 x 12	
MONGUZI	103 3300-120-12 MON	3300 x 120 x 12	
MONGUZI	103 3350-240-10 MON	3350 x 240 x 10	
MONGUZI	103 3750-120-12 MON	3750 x 120 x 12	
MONGUZI	103 4060-235-15 MON	4060 x 235 x 15	
MONGUZI	103 4110-200-15 MON	4110 x 200 x 15	
MONGUZI	103 4130-200-15 MON	4130 x 200 x 15	
MONGUZI	103 4140-180-15 MON	4140 x 180 x 15	
MONGUZI	103 4170-190-15 MON	4170 x 190 x 15	
NORMACA	103 2700-100-10 NOR	2720 x 100 x 10	
NPLS	103 2730-180-15 NPL W	2730 x 180 x 15	
OLM	103 100-100-100 OLM	100 x 100 x 100	
PELLER	103 2788-160-15,5 PEL	2788 x 160 x 15,5	
PELLER	103 2800-127-12,7 PEL	2800 x 127 x 12,7	
PELLER	103 2892-170-15 PEL	2892 x 170 x 15,5	

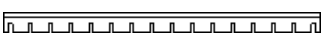
103 Nože na dýhu - Veneer knives - Furniermesser - Nože do plyn fornirowanych

MANUFACTURER	CODE	SIZE mm	PLAN
PELLER	103 2900-75-8 PEL	2900 x 75 x 8	
RAPIDEX	103 900-130-10 RAP	900 x 130 x 10	
RAPIDEX	103 1090-130-12 RAP	1090 x 130 x 12	
RAPIDEX	103 1168-190-15 RAP	1168 x 190 x 15	
RAPIDEX	103 1400-140-12 RAP	1400 x 140 x 12	
RAUTE	103 1400-180-16 RAU W	1400 x 180 x 16	
RAUTE	103 1400-197-16 RAU W	1400 x 197 x 16	
RAUTE	103 1400-200-16 RAU	1400 x 200 x 16	
RAUTE	103 1450-190-16 D	1450 x 190 x 16	
RAUTE	103 1500-180-16 RAU	1500 x 180 x 16	
RAUTE	103 1680-55-13 RAU W	1680 x 55 x 13	
RAUTE	103 1680-197-16 RAU W	1680 x 55 x 13	
RAUTE	103 2645-197-16 RAU W	2645 x 197 x 16	
RAUTE	103 2650-200-16 RAU	2650 x 200 x 16	
RFR	103 2769-190,5-16 RFR	2769 x 190,5 x 16	
ROLLER	103 2365-160-15 ROL	2365 x 160 x 15	
RUKLE	103 3040-120-14 RUK B	3040 x 120 x 14	
RUKLE	103 3040-120-18 RUK B	3140 x 100 x 18	

103 Nože na dýhu - Veneer knives - Furniermesser - Nože do płyt fornirowanych

MANUFACTURER	CODE	SIZE mm	PLAN
SODEME	103 950-150-15 SOD	950 x 150 x 15	
TAKEKANA	103 1180-135-14 TAK	1180 x 135 x 14	
TAKEKANA	103 2010-140-13 TAK	2010 x 140 x 13	
TEMIL	1400-220-16 TEM	1400 x 220 x 16	
TEMIL	103 1800-220-16 TEM	1800 x 220 x 16	
TEMIL	103 1848-180-15 EUR	1848 x 180 x 15	
TEMIL	103-1900-180-16 TEM	1900 x 180 x 16	
TEMIL	103 2700-220-16 TEM	2700 x 220 x 16	
TEMIL	103 2700-220-18 TEM	2700 x 220 x 18	
UROKO	103 2760-200-16 URO	2760 x 200 x 16	
UROKO	103 2769-190,5-16 URO	2769 x 190,5 x 16	
UROKO	103 3565-130-16 URO	3565 x 130 x 16	
VALETTE	103 620-120-10 VAL	620 x 120 x 10	
VALETTE	103 700-170-16 VAL	700 x 170 x 16	
VALETTE	103 838-180-15 VAL	838 x 180 x 15	

104 Roztrieskovacie nože - Flaker knives - Zerspanermesser - Noże do rębaków











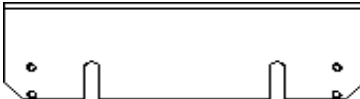

MANUFACTURER	CODE	SIZE mm	PLAN
CAE	104 469-69,8-5 CAE	469 x 69.8 x 5	
CAE	104 470-67-5 CAE	470 x 67 x 5	
CAE	104 470-69,8-5 CAE	470 x 69.8 x 5	
CAE	104 725,5-82,5-6,35 CAE	725.5 x 82.5 x 6.35	
HOMBAK	104 180-65-4 HOM	180 x 65 x 4	
HOMBAK	104 271-57-4 HOM	271 x 57 x 4	
HOMBAK	104 297-57-4 HOM	297 x 57 x 4	
HOMBAK	104 325-57-4 HOM	325 x 57 x 4	
HOMBAK	104 353-57-4 HOM	353 x 57 x 4	
HOMBAK	104 355-74-4 HOM	355 x 74 x 4	
HOMBAK	104 363-57-4 HOM	363 x 57 x 4	
HOMBAK	104 370-57-4 HOM	370 x 57 x 4	
KLOCKNER	104 490-90-4 KLO	490 x 90 x 4	

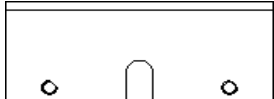
Eurotools, s.r.o.
 Bagarova 2B
 036 01 Martin
 Slovakia, Europe

tel: 00421 43 4220262
 Fax: 043 43 4220262
 e mail: info@eurotools.sro.sk
 WEB: www.eurotools.sro.sk















104 Roztrieskovacie nože - Flaker knives - Zerspanermesser - Noże do rębaków

MAIER	104 333-100-5 MAI	333 x 100 x 5	
KLOCKNER	104 334-100-5 MAI	334 x 100 x 5	
KLOCKNER	104 464-90-5 MAI	464 x 90 x 5	
KLOCKNER	104 464-100-5 MAI	464 x 100 x 5	
KLOCKNER	104 464-100-6 MAI	464 x 100 x 6	
PALLMANN	104 179-74-5 PAL	179 x 74 x 5	
PALLMANN	104 299-75-5 PAL	299 x 75 x 5	
PALLMANN	104 299-100-5 PAL	299 x 100 x 5	
PALLMANN	104 374-100-5	374 x 100 x 5	
PALLMANN	104 399-55-6 PAL	399 x 55 x 6	
PALLMANN	104 449-75-5 PAL	449 x 75 x 5	
PALLMANN	104 449-90-3 PAL	449 x 90 x 3	
PALLMANN	104 449-90-5 PAL	449 x 90 x 5	











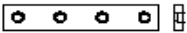
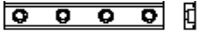
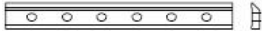

Eurotools, s.r.o.
 Bagarova 2B
 036 01 Martin
 Slovakia, Europe

tel: 00421 43 4220262
 Fax: 043 43 4220262
 e mail: info@eurotools.sro.sk
 WEB: www.eurotools.sro.sk

104 Roztrieskovacie nože - Flaker knives - Zerspanermesser - Noże do rębaków

PALLMANN	104 449-90-5 PAL	449 x 90 x 5	
PALLMANN	104 449-90-5 PAL	449 x 90 x 5	
PALLMANN	104 449-100-5 PAL	449 x 100 x 5	
PALLMANN	104 480-90-5 PAL	480 x 90 x 5 mm	
PALLMANN	104 501-90-4 PAL	501 x 90 x 4	
PALLMANN	104 524-90-5 PAL	524 x 90 x 5	
PALLMANN	104 524-100-5 PAL	524 x 100 x 5	
PALLMANN	104 599-75-5 PAL	599 x 75 x 5	
PALLMANN	104 678-83-5 PAL	678 x 83 x 5	
PALLMANN	104 729-83-5 PAL	726 x 83 x 5	
PALLMANN	104 803-83-5 PAL	803 x 83 x 5	
PESSA	103 559-100-5 PES	559 x 100 x 5	

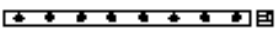
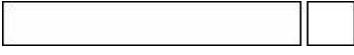
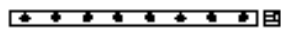
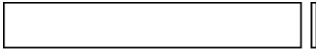
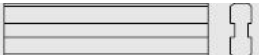
108 Protinože - Counterknives - Gegenmesser -

MANUFACTURER	CODE	SIZE	PLAN
BRUCKS	108 370-68-23 BRU	370x68x23	
BRUCKS	108 370-68-23 BRU 2	370x68x23	
BRUCKS	108 390-50-15 BRU	390x50x15	
BRUCKS	108 435-98-24 BRU	435x98x24	
BRUCKS	108 436-68-24 BRU	436x68x24	
BRUCKS	108 450-50-15 BRU	450x50x15	
BRUCKS	108 496-68-24 BRU	496x68x24	
BRUCKS	108 515-50-15 BRU	515x50x15	
BRUCKS	108 550-78-24 BRU	550x78x24	
BRUCKS	108 800-58-55 BRU	800 X 58 X 55	
DMECHANIK	108 428-33-25 DME Dr	428 x 33 x 25	
DMECHANIK	108 600-38-28 DME Dr	600 x 38 x 28	
EUROTOOLS	108 470-36-28 EUR CA	470 x 36 x 28	
EUROTOOLS	108 550-70-70 EUR G	550 x 70 x 70	
EUROTOOLS	108 630-40-40 EUR A	630 x 40 x 40	
EUROTOOLS	108 880-100-20 EUR C	880 x 100 x 20 mm	
COMACT	108 260-77.5-27 COM	260x77.5x27	
COMACT	108 371-76-26 COM	371x76x26	

108 Protinože - Counterknives - Gegenmesser -

MANUFACTURER	CODE	SIZE	PLAN
COMACT	108 378-50-14 COM	378x50x14	
COMACT	108 483-50-13 COM	483x50x13	
ERJO	108 389-90-30 ERJ	389x90x30	
ERJO	108 450-110-22 ERJ	450x110x22	
ERJO	108 450-98-19 ERJ	450x98x19	
ERJO	108 550-100-20 ERJ	550x100x20	
ERJO	108 550-110-18.5 ERJ	550x110x18.5	
FERRARI	108 460-40-40 FER	460x40x40	
FERRARI	108 630-40-40 FER	630x40x40	
FERRARI	108 930-40-40 FER	930x40x40	
GUSTIN	108 296-140-40 GUS	296x140x40	
GUSTIN	108 310-70-45 GUS	310x70x45	
GUSTIN	108 395-145-40 GUS	395x145x40	
HEDLUND	108 415-78-38 HED	415x78x38	
HEINOLA-AHLSTROM	108 630-100-20 HEI	630x100x20	
HEINOLA-AHLSTROM	108 630-100-20 HEI	630x100x20	
KLOCKNER	108 430-33-25 KLO	430x33x25	
KLOCKNER	108 450-80-60 KLO W	450x80x60	
KLOCKNER	108 485-34-10 KLO	485x34x10	
KLOCKNER	108 530-33-18 KLO	530x33x18	
KLOCKNER	108 530-33-25 KLO N	530x33x25	
KLOCKNER	108 630-33-25 KLO	630x33x25	
KLOCKNER	108 690-50-40 KLO	690x50x40	
KLOCKNER	108 780-100-20 KLO	780x100x20	
KLOCKNER	108 830-33-33 KLO	830x33x33	
KLOCKNER	108 830-59-39 KLO	830x59x39	
KLOCKNER	108 830-60-40 KLO N	830x60x40	

108 Protinože - Counterknives - Gegenmesser -









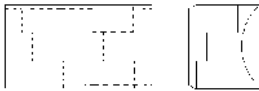

MANUFACTURER	CODE	SIZE	PLAN
KLOCKNER	108 940-100-20 KLO	940x100x20	
KLOCKNER	108 1100-100-20 KLO	1100x100x20	
KOCKUM/ESTERER	108 25/34-48-6/15 KOC L	25/34x48x6/15	
KOCKUM/ESTERER	108 25/34-48-6/15 KOC R	25/34x48x6/15	
KOCKUM/ESTERER	108 30-50-15 KOC L	30x50x15	
KOCKUM/ESTERER	108 30-50-15 KOC R	30x50x15	
LINK	108 120-85-18 LIN	120x85x18	
LINK	108 270-130-17 LIN	270x130x17	
PALLMAN	108 295-40-8 PAL	295x40x8	
PALLMAN	108 610-70-12 PAL	610x70x12	
PALLMAN	108 630-80-15 PAL	630x80x15	
PALLMAN	108 800-60-45 PAL	800x60x45	
PRECISION	108 298.5-76.4-25.5 PRE	298.5x76.4x25.5	
PRECISION	108 330-76-18 PRE	330x76x18	
PRECISION	108 374.5-54-9.5 PRE	374.5x54x9.5	
PRECISION	108 400-76-26 PRE	400x76x26	
RAUTE	108 1130-33-25 RAU B	1130x33x25	
RAUMA	108 919-93-9 RAU	919x93x9	
RUDNICK	108 680-50-20 RUD	680x50x20	
RUDNICK	108 800-55-15 RUD	800x55x15	
RUDNICK	108 850-60-45 RUD K3	850x60x45	
RUDNICK ENNERS	108 1020-80-15 RUD O	1020x80x15	
RUDNICK	108 1040-120-20 RUD	1040x120x20	
SEGEM	108 140-60-14 SEG	140x60x14	
SEGEM	108 180-60-8 SEG	180x60x8	
SEGEM	108 190-60-14 SEG	190x60x14	
SEGEM	108 200-85-49.31 SEG	200x85x49.31	
SEGEM	108 325-100-30 SEG	325x100x30	
SEGEM	108 350-50-28/30 SEG	350x50x28/30	
SEGEM	108 360-60-15 SEG	360x60x15	

108 Protinože - Counterknives - Gegenmesser -

MANUFACTURER	CODE	SIZE	PLAN
SEGEM	108 360-100-30 SEG	360x100x30	
SEGEM	108 430-40-12 SEG	430x40x12	
SEGEM	108 450-85-49.31 SEG	450x85x49.31	
SEGEM	108 460-60-10 SEG	460x60x10	
SEGEM	108 480-70-12 SEG	480x70x12	
SEGEM	108 486-36-8 SEG	486x36x8	
SEGEM	108 498-58-9.5 SEG	498x58x9.5	
SEGEM	108 580-60-12 SEG	580x60x12	
SEGEM	108 616-80-12 SEG	616x80x12	
SEGEM	108 640-80-14 SEG	640x80x14	
SEGEM	108 680-80-14 SEG	680x80x14	
SEGEM	108 760-100-20 SEG	760x100x20	
SEGEM	108 830-76-18 SEG	830x76x18	
SEGEM	108 940-80-14 SEG	940x80x14	
VECOPLAN	108 500-25-5 VEC	500x25x5	
VECOPLAN	108 580-25-5 VEC	580x25x5	
VECOPLAN	108 800-25-5 VEC	800x25x5	
VECOPLAN	108 880-75-25 VEC	880x75x25	
ZENO	108 540-50-20 ZEN O	540 x 50 x 20	

Iné rozmery na požiadanie
 Other dimensions available upon request
 Andere Produktion auf Anfrage

111 Odkôňovacie nože - Debarker knives - Entrindungsmesser - Nože

MANUFACTURER	CODE	SIZE mm	PLAN
BEZNER	111 75-40-4 BEZ	75 x 40 x 4	
EDER	111 40-30-4 EDE	40 x 30 x 4	
EUROTOOLS	111 60-40 - 40 EUR	60 x 40 x 40	
EUROTOOLS	111 62-40-40 EUR		
MATELEST	111 106-90 MAT	106 x 90	
MATELEST	111 70-55 MAT	70 x 55	
POSCH	111 151-45-5 POS p	151 x 45 x 5	
SCHUTTLE	111 77-32-7,6 SCH	77 x 32 x 7,6	
SCHUTTLE	111 77-40-5 SCH	77 x 40 x 5	
SEGEM	111 50-45 SEG	50 x 45	
SEGEM	111 60-57 SEG	60 x 57x14	
SPÉCIAL	111 60-40 - 40 SPE	60 x 40 x 40	

114 | Korunkové nože -Shredder knives - Schneidkronen - Nože koronkowe

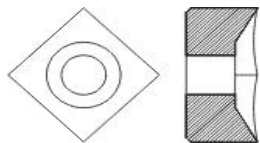
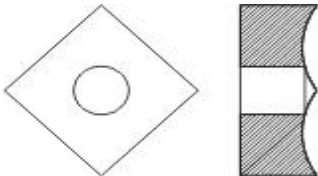
MANUFACTURER	CODE	SIZE	PLAN
EUROTOOLS	114 24-24-16 EUR	24 x 24 x 16	
EUROTOOLS	114 38-38-18 EUR	38 x 38 x 18	
EUROTOOLS	114 38-38-22 EUR	38 x 38 x 22	
EUROTOOLS	114 25-25-14 EUR	25 x 25 x 14	
EUROTOOLS	114 38-38-18 EUR	38 x 38 x 18	
EUROTOOLS	114 40-40-20 EUR	40 x 40 x 20	
EUROTOOLS	114 38-38-12 EUR	38 x 38 x 12	
EUROTOOLS	114 30-30-15 EUR	30 x 30 x 15	
EUROTOOLS	114 30-30-15 EUR	30 x 30 x 15	

Eurotools, s.r.o.
 Bagarova 2B
 036 01 Martin
 Slovakia, Europe

tel: 00421 43 4220262
 Fax: 043 43 4220262
 e mail: info@eurotools.sro.sk
 WEB: www.eurotools.sro.sk

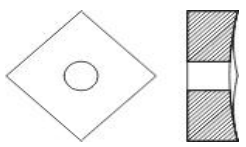
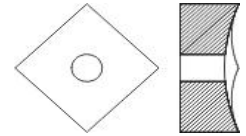
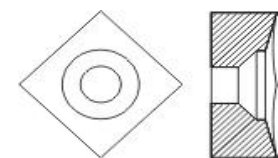
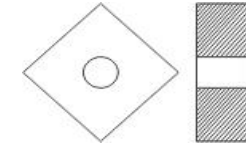
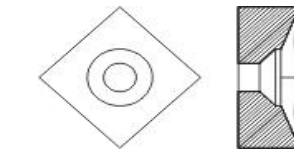
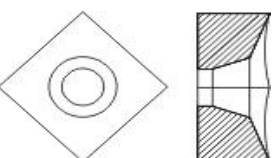
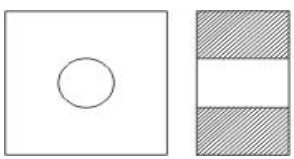
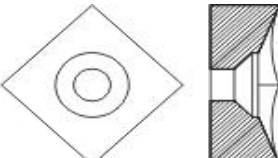
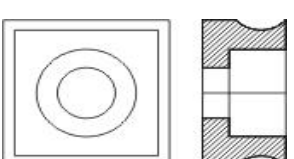
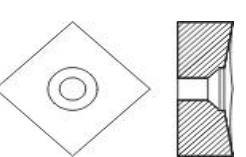
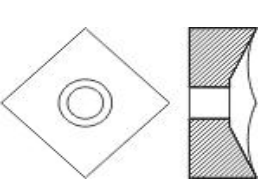

114 | Korunkové nože -Shredder knives - Schneidkronen - Nože koronkowe

EUROTOOLS	114 38-38-18 EUR	38 x 38 x 18	
EUROTOOLS	114 40-40-23 EUR	40 x 40 x 23	
EUROTOOLS	114 30-30-17 EUR	30 x 30 x 17	
EUROTOOLS	114 38-38-18 EUR	38 x 38 x 18	
EUROTOOLS	114 43-43-23 EUR	43 x 43 x 23	
EUROTOOLS	114 30-30-18 EUR	30 x 30 x 18	
EUROTOOLS	114 35-35-20 EUR	35 x 35 x 20	
EUROTOOLS	114 43-43-23 EUR	43 x 43 x 23	
EUROTOOLS	114 50-50-25 EUR	50 x 50 x 25	
EUROTOOLS	114 60-60-30 EUR	60 x 60 x 30	
EUROTOOLS	114 80-80-45 EUR	80 x 80 x 45	

Eurotools, s.r.o.
 Bagarova 2B
 036 01 Martin
 Slovakia, Europe

tel: 00421 43 4220262
 Fax: 043 43 4220262
 e mail: info@eurotools.sro.sk
 WEB: www.eurotools.sro.sk



EUROTOOLS

114 60-60-55 EUR

60 x 60 x 25.....

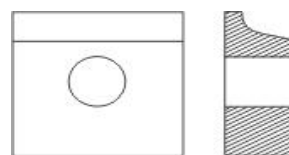

EUROTOOLS

114 60-60-30 EUR

60 x 60 x 30

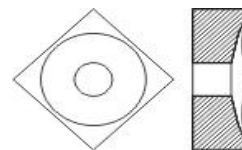

EUROTOOLS

114 80-80-45 EUR

80 x 80 x 45

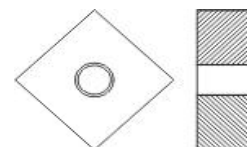

EUROTOOLS

114 62-62-27 EUR

62 x 27

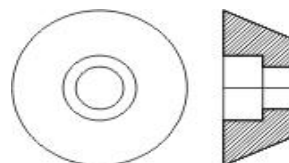

EUROTOOLS

114 60-60-30 EUR

60 x 60 x 30

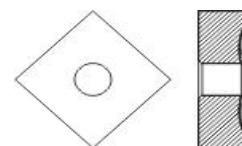

EUROTOOLS

114 95-95-27 EUR

95 x 95 x 27

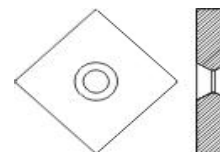

EUROTOOLS

114 80-80-18 EUR

80 x 80 x 18.....

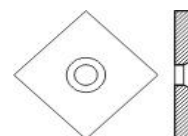

EUROTOOLS

114 60-60-30 EUR

60 x 60 x 30

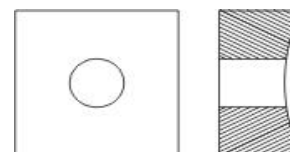

EUROTOOLS

114 100-100-50 EUR

100 x 100 x 50

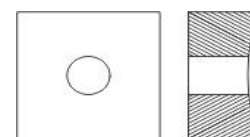

EUROTOOLS

114 94-94-39 EUR

94 x 94 x 39

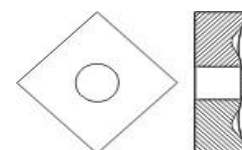

Eurotools, s.r.o.
Bagarova 2B
036 01 Martin
Slovakia, Europe

tel: 00421 43 4220262
Fax: 043 43 4220262
e mail: info@eurotools.sro.sk
WEB: www.eurotools.sro.sk

114 | Korunkové nože -Shredder knives - Schneidkronen - Nože koronkowe

EUROTOOLS

114 60-60-30 EUR

60 x 60 x 30

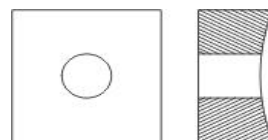

EUROTOOLS

114 108-108-39 EUR

108 x 108 x 39

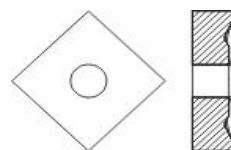

Multigroove circular knives

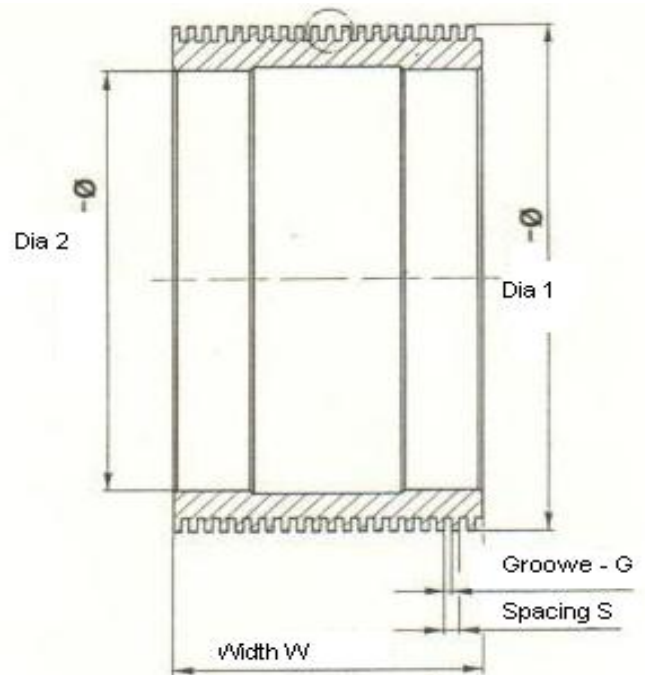
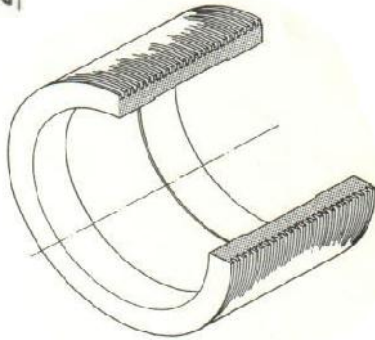
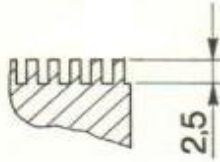
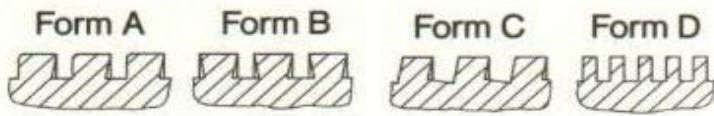

STANDARD SIZES mm

Dia1	77	80	105	124	180	250	290	390	400
Dia2	60	65	80	100	150	210	260	350	360
Spacing S from	5	5	5	5	5	5	5	5	5
Groove G from	2,2	2,2	2,2	2,2	2,2	2,2	2,2	2,2	2,2

Form: A,B,C,D

Standard Width W : 50 / 100 mm

Dia1	80	105	150	150	160	190	250	290	390
Dia2	60	90	100	120	130	160	210	260	350
Spacing S from	2	2	2	2	2	2	2	2	2
Groove G from	1	1	1	1	1	1	1	1	1

Form: D

Standard Width W : 50 / 100 mm

STANDARD MATERIALS USED: 1.2080, 1.2552, 1.2235, 1.2067 (OTHERS ON REQUEST)

Cutting discs Type 1

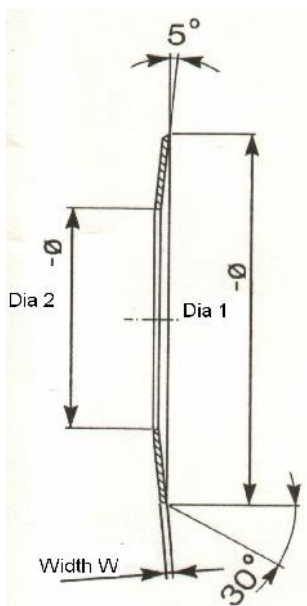
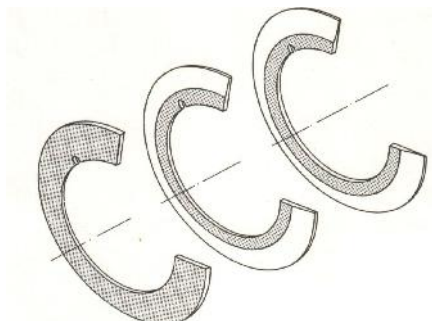
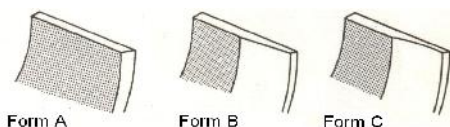

STANDARD SIZES mm

Dia1	62	75	75	75	90	100	105	105
Dia2	40	40	45	50	60	70	65	75
Width W	0,6 / 1,0	1,0	0,6 / 1,0	0,6 / 1,0	1,2	0,8 / 1,2	0,8 / 1,2	0,8 / 1,2

Form: A,B,C,

Dia1	105,6	108	130	130	140	170
Dia2	81,05	65	80	100	70	120
Width W	1,24	1,2	1,5	1,5	3,0	2,0

Form: A,B,C,

STANDARD MATERIALS USED: 1.2080, 1.2379, 1.2235, 1.2067, 1.2436, 1.3333, 1.3343 (OTHERS ON REQUEST)

Cutting discs Type 2

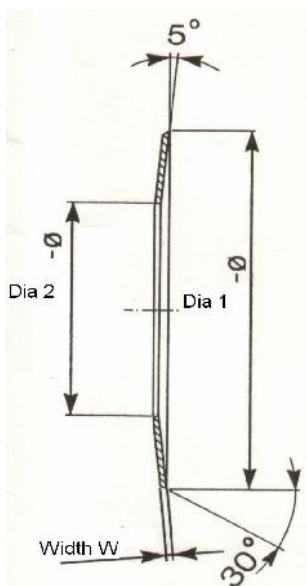
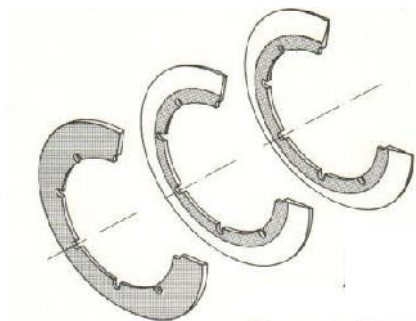
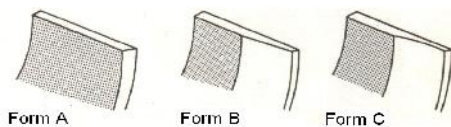

STANDARD SIZES mm

Dia1	75	75	80	105
Dia2	40	45	40	70
Width W	0,4 / 0,6	0,4 / 0,6	0,6	0,4 / 0,6

Form: A,B,C,

STANDARD MATERIALS USED: 1.2080, 1.2379, 1.2235, 1.2067, 1.2436, 1.3333, 1.3343 (OTHERS ON REQUEST)

Cutting knives Type 1

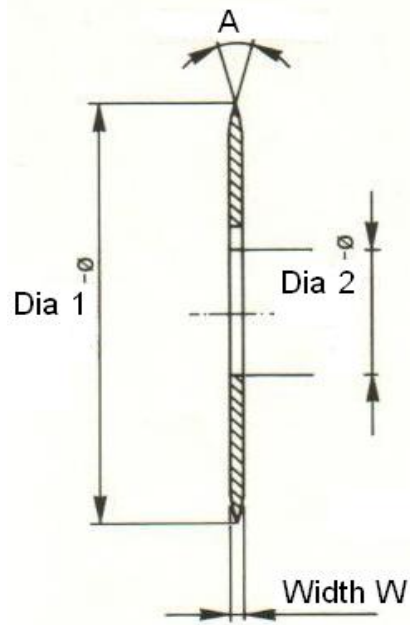
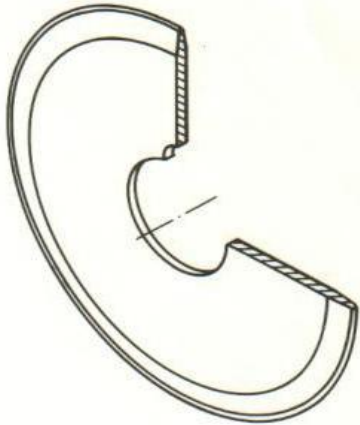

STANDARD SIZES mm

Dia1	100	105	120	150
Dia2	30	55	30	30
Width W	1,0	1,5	1,0	2,0
Angle A:				

STANDARD MATERIALS USED: 1.2080, 1.2379, 1.2235, 1.2067, 1.2436, 1.3333, 1.3343 (OTHERS ON REQUEST)

Cutting knives Type 2

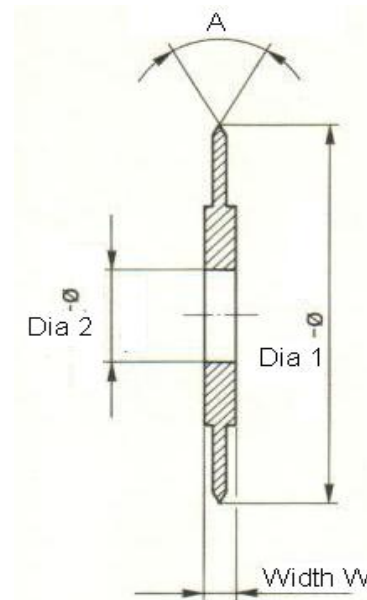
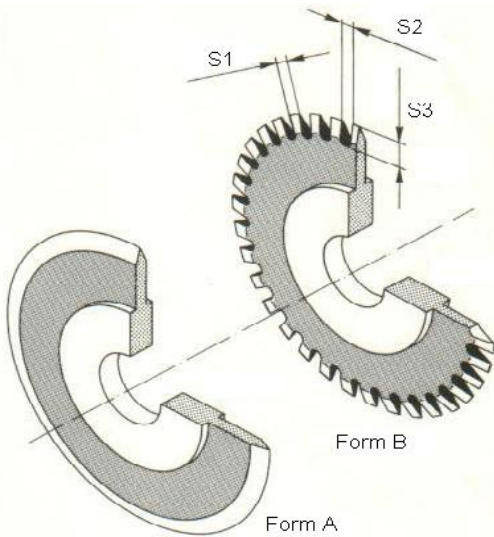

STANDARD SIZES mm

Dia1	77	77
Dia2	19	19
Width W	5,2	6,35
Angle A:		

STANDARD MATERIALS USED: 1.2080, 1.2379, 1.2235, 1.2067, 1.2436, 1.3333, 1.3343 (OTHERS ON REQUEST)

Counterknives Type 1

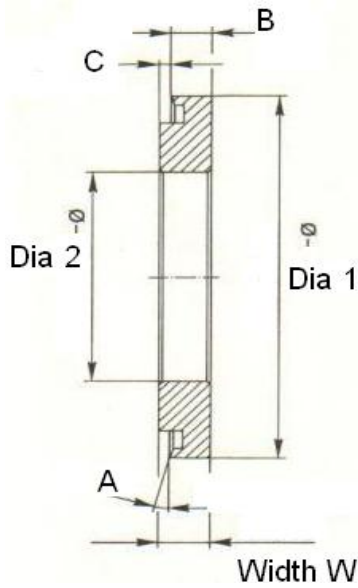
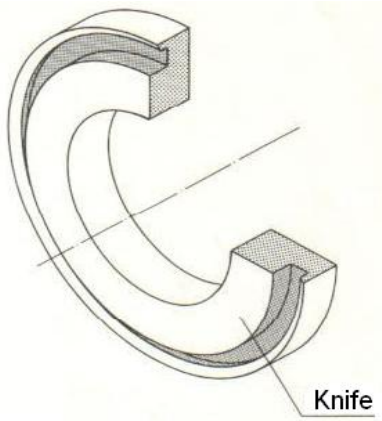

STANDARD SIZES mm

Dia1	46	60	77	77	80	105	105	150
Dia2	30	40	45	60	60	80	90	120
Width W	3,0	3,0	3,0	3,0	3,0	5,0	5,0	5,0

Angle A:

STANDARD MATERIALS USED: 1.2080, 1.2379, 1.2235, 1.2067, 1.2436, (OTHERS ON REQUEST)

Counterknives Type 2

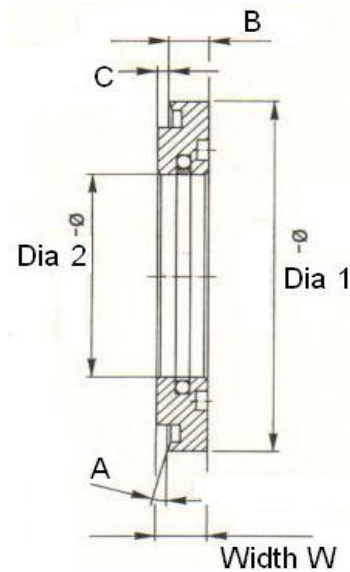
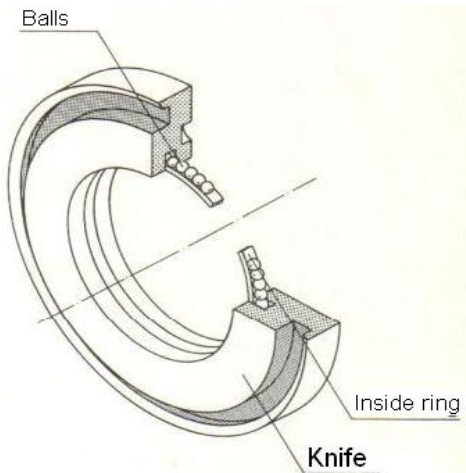

STANDARD SIZES mm

Dia1	46	60	60	77	77	80	90	105
Dia2	25	30	40	45	60	60	60	60
Width W	6,0	6,0	6,0	6,0	6,0	6,0	10,0	10,0

Angle A:

Dia1	105	150
Dia2	80	120
Width W	10,0	15,0

Angle A:

STANDARD MATERIALS USED: 1.2080, 1.2379, 1.2235, 1.2067, 1.2436, (OTHERS ON REQUEST)

Counterknives Type 3

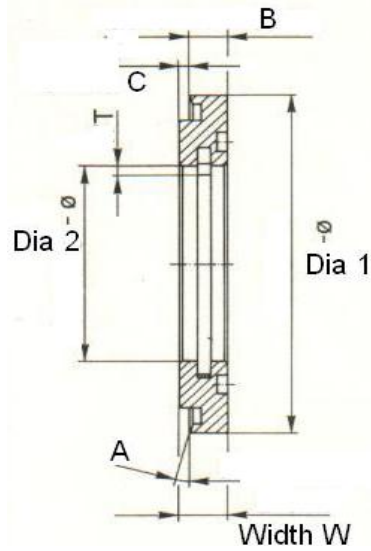
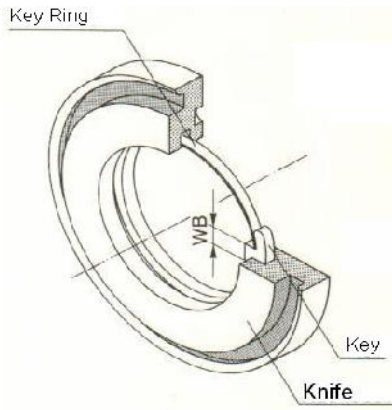

STANDARD SIZES mm

Dia1	46	60	60	77	77	80	90	105
Dia2	25	30	40	45	60	60	60	60
Width W	6,0	6,0	6,0	6,0	6,0	6,0	10,0	10,0
Angle A:								

Dia1	105	150
Dia2	80	120
Width W	10,0	15,0
Angle A:		

STANDARD MATERIALS USED: 1.2080, 1.2379, 1.2235, 1.2067, 1.2436, (OTHERS ON REQUEST)

Counterknives Type 4

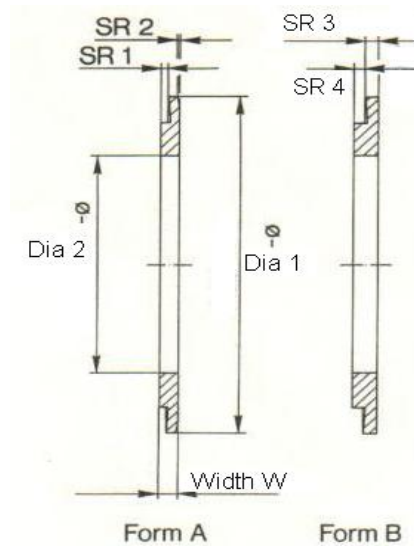
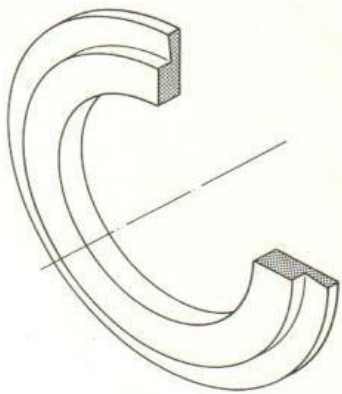











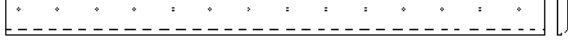

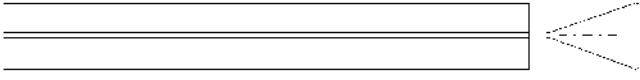

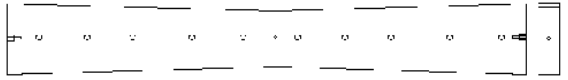
STANDARD SIZES mm





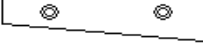

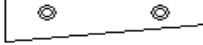



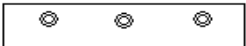

Dia1	46	77	80
Dia2	30	45	60
Width W	1,0	2,0	2,0

STANDARD MATERIALS USED: 1.2080, 1.2379, 1.2235, 1.2067, 1.2436, (OTHERS ON REQUEST)

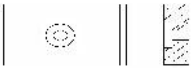

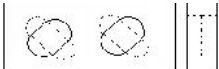

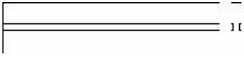
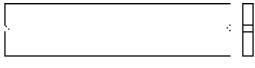

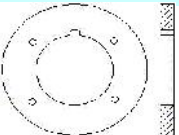

301 Nože na kov - Knives for steel - Messer für Metall - Nože do metalu

MANUFACTURER	CODE	SIZE mm	PLAN
EUROTOOLS	301 1070-45-20 EUR L	1100 x 45 x 20	
EUROTOOLS	301 1100-54-20 EUR L	1100 x 54 x 20	
EUROTOOLS	301 1262-58-10 EUR L	1262 x 58 x 10	
EUROTOOLS	301 1350-80-20 EUR L	1270 x 57,15 x 9,52	
EUROTOOLS	301 1350-80-20 EUR L	1350 x 80 x 20	
EUROTOOLS	301 1380-173-123 EUR L	1380 x 173 x 123	
EUROTOOLS	301 1430-178-32 EUR L	1430 x 178 x 32	
EUROTOOLS	301 1645-157-30 EUR L	1645 x 157 x 30	
EUROTOOLS	301 1650-100-30 EUR L	1650 x 100 x 30	
VATECH	300 1700-54-20 EUR I	1700 x 80 x 20 mm	
EUROTOOLS	300 1700-110-35 EUR L	1700 x 110 x 35 mm	
EUROTOOLS	301 1800-114-32 EUR L	1800 x 114 x 32	
EUROTOOLS	301 1800-166-32 EUR L	1800 x 166 x 32	
EUROTOOLS	304 750-115/170,5-100 EUR W	750 x 170,5 x 100	
EUROTOOLS	304 580-170,5-100 EUR W	580 x 170,5 x 100	
EUROTOOLS	304 750-115/170,5-100 EUR W	750 x 170,5 x 100	

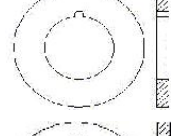
301 Nože na kov - Knives for steel - Messer für Metall - Noże do metalu

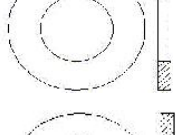
MANUFACTURER	CODE	SIZE mm	PLAN
EUROTOOLS	304 750-160-70 EUR W	750 x 160 x 70	
EUROTOOLS	304 580-160-70 EUR W	580 x 160 x 70	
EUROTOOLS	304 900-150-100 EUR W	900 x 150 x 100	
EUROTOOLS	304 900-152/169-100 EUR W	900 x 152/169 x 100	
EUROTOOLS	304 900-169/174-100 EUR W	900 x 174 x 100	
EUROTOOLS	304 750-174/169-100 EUR W	900 x 174 x 100	
EUROTOOLS	304 900-169/152-100 EUR W	900 x 169/152 x 100	
EUROTOOLS	303 84,5-30-28 EUR L	84,5 x 30 x 28	
EUROTOOLS	303 135-63-25 EUR L	135 x 63 x 25	
EUROTOOLS	303 141-63-25 EUR L	141 x 63 x 25	
EUROTOOLS	303 150-80-27 EUR L	150 x 80 x 27	
EUROTOOLS	303 165-55-20 EUR L	165 x 55 x 20	
EUROTOOLS	303 300-75-40 EUR L	300 x 75 x 40	
EUROTOOLS	303 300-75-40 EUR U	300 x 75 x 40	
EUROTOOLS	303 468-82,5-32 EUR	468 x 82,5 x 32	

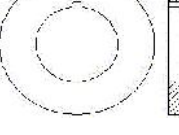
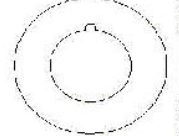
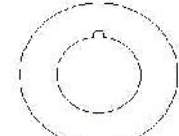
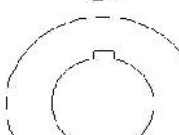
302 | Kotúčové nože na kov - Circular Knives for steel - Messer für Metall - Nože do metalu

MANUFACTURER	CODE	SIZE mm	PLAN
EUROTOOLS	302 190/90-20 EUR L	190/90 -20 mm	
EUROTOOLS	302 200/70-25 EUR L	200/70 -25 mm	
EUROTOOLS	302 200/145-5 EUR L	200/145 -5 mm	
EUROTOOLS	302 200/110-30 EUR L	200/110 -30 mm	
EUROTOOLS	302 250/140-20 EUR L	250/145-20 mm	
EUROTOOLS	302 255/165-10 EUR L	255/165-10 mm	
EUROTOOLS	302 300/152-38 EUR L	300/152-38 mm	
EUROTOOLS	302 350/190-30 EUR L	350/190-30 mm	
EUROTOOLS	302 406/216-38 EUR L	406/216-38 mm	
EUROTOOLS	302 420/165-40 EUR L	420/165-40 mm	
EUROTOOLS	302 460/300-30 EUR L	460/300-30 mm	
EUROTOOLS	302 500/300-40 EUR L	500/300-40 mm	

Eurotools, s.r.o.
 Bagarova 2B
 036 01 Martin
 Slovakia, Europe

tel: 00421 43 4220262
 Fax: 043 43 4220262
 e mail: info@eurotools.sro.sk
 WEB: www.eurotools.sro.sk

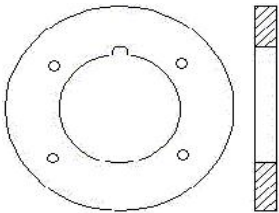
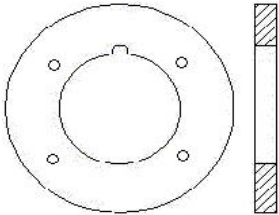

302 | Kotúčové nože na kov - Circular Knives for steel - Messer für Metall - Nože do metalu

MANUFACTURER	CODE	SIZE mm	PLAN
EUROTOOLS	302 650/300-50 EUR L	650/300-50 mm	
EUROTOOLS	302 650/300-55 EUR L	650/300-55 mm	

306 Vymedzovacie krúžky - Reduction Rings - Reduktiv ring -

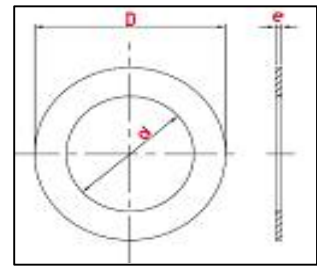

MANUFACTURER	CODE	SIZE mm	VARIATIONS
EUROTOOLS	306 240-200-1 EUR V	Ř 240 / 200 - 1	WIDTH - 1,2,3,5,10,20,30,50 mm
EUROTOOLS	306 156-110-19,6 EUR C	Ř 156 / 110 - 19,6	DIFFERENT SIZES
EUROTOOLS	306 156-110-19,6 EUR C	Ř 218 / 120 - 76,4	WIDTH - 76,4; 96,4; 126,4 mm



Ďalšie rozmery nožov dodávame podľa dohody.

Other types of knives available on demand .

Andere Abmessungen auf Anfrage.

Istnieje możliwość zrealizowania innych wykonań i rozmiarów .

506 Sitá - Sieves - Screens - Sita

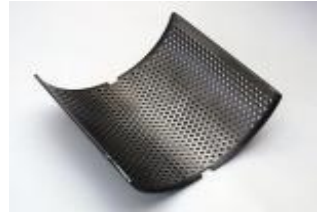
MANUFACTURER	CODE	SIZE mm	PLAN
ELDAN	506 EI	dia 3 - 40 mm	
LINDNER KOMET	506 LK	dia 10 - 100 mm	
LINDNER POWER KOMET	506 LPK	dia 10 - 100 mm	
LINDNER MICROMAT 1500	506 LM 1500	dia 15 - 80 mm	
LINDNER MICROMAT 2000	506 LM 2000	dia 15 - 80 mm	
LINDNER JUPITER	506 LJ	dia 100 - 300 mm	
LINDNER VEGA	506 LV	dia 15 - 50 mm	
MEWA	506 MW	dia 15 - 50 mm	
UNTHA	506 UN	dia 15 - 50 mm	
ZERMA	506 ZE	dia 15 - 50 mm	

902 Nože na gumu - Knives for rubber - Messer für Gimmi - Nože do gimí

MANUFACTURER	CODE	SIZE mm	PLAN
ELDAN	904 216-211-40 ELD	216 x 211 x 40	
ELDAN	904 245-233-50 ELD	245 x 233 x 50	
ELDAN	904 245-168-50 ELD L	245 x 233 x 50	
ELDAN	904 245-168-50 ELD R	245 x 233 x 50	
ELDAN	904 475-100-20 ELD R	475 x 100 x 20	
ELDAN	904 399-66-25 ELD	399 x 66 x 25	
ELDAN	904 218-80-40 ELD	218 x 80 x 40	
EUROTOOLS	902 230/50,8-7 EUR M	200/70 -25	
EUROTOOLS	902 900-35-3 EUR M	900 X 35 X 3	
EUROTOOLS	902 1010-35-3 EUR M	1010 X 35 X 3	
EUROTOOLS	902 1010-45-3 EUR M	1010 X 45 X 3	
EUROTOOLS	902 1200-45-3 EUR M	1200 X 45 X 3	

Eurotools, s.r.o.
 Bagarova 2B
 036 01 Martin
 Slovakia, Europe

tel: 00421 43 4220262
 Fax: 043 43 4220262
 e mail: info@eurotools.sro.sk
 WEB: www.eurotools.sro.sk



902 Nože na gumu - Knives for rubber - Messer für Gimmi - Nože do gimi



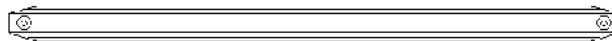

EUROTOOLS

902 1300-35-3 EUR M



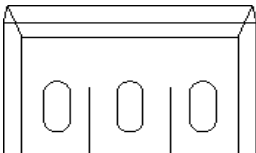
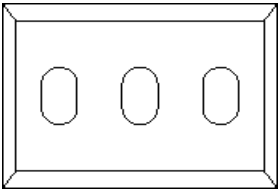

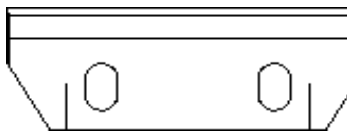

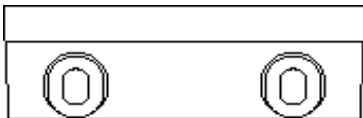
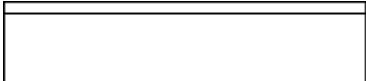
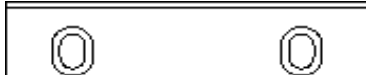
1300 X 35 X 3



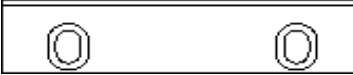

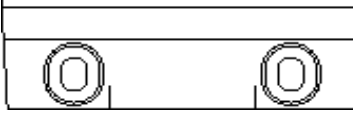
904 Nože na plast -For Plastics - Fur Kunststoff - Nože do plastiku

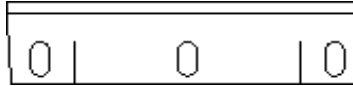
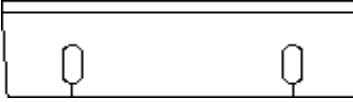
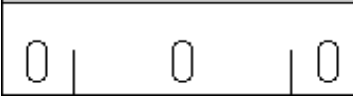
MANUFACTURER	CODE	SIZE mm	PLAN
ALPINE	904 125-83-16 ALP	125 x 83 x 16	
ALPINE	904 140-104-12 ALP	140 x 104 x 12	
ALPINE	904 197-85-15 ALP	197 x 85 x 15	
ALPINE	904 200-85-15 ALP	200 x 85 x 15	
ALPINE	904 210-79-20 ALP	210 x 79 x 20	
ALPINE	904 210-90-20 ALP	210 x 90 x 20	
CMB WITTMANN	904 150-53-14 CMB	150 x 53 x 14	
CMB WITTMANN	904 153-38-9.5 CMB	153 x 38 x 9.5	
CMB WITTMANN	904 159-38-16 CMB	159 x 38 x 16	

904 Nože na plast -For Plastics - Fur Kunststoff - Nože do plastiku

CMB WITTMANN	904 159-38-16 CMB	159 x 38 x 16	
CMB WITTMANN	904 215-76-18 CMB	215 x 76 x 18	
CMB WITTMANN	904 217.5-76-22 CMB	217.5 x 76 x 22	
CMB WITTMANN	904 249-118-25 CMB	249 x 118 x 25	
CMB WITTMANN	904 296-76-18 CMB	296 x 76 x 18	
CMB WITTMANN	904 395-118-25 CMB	395 x 118 x 25	
CMB WITTMANN	904 399-118-25 CMB	399 x 118 x 25	
CMB WITTMANN	904 439.5-76-18 CMB	439.5 x 76 x 18	
CMB WITTMANN	904 495-118-25 CMB	CMB 495 x 118 x 25	

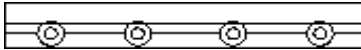
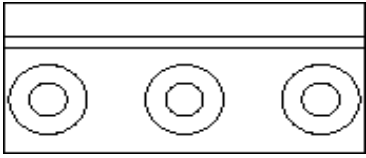
904 Nože na plast -For Plastics - Fur Kunststoff - Nože do plastiku

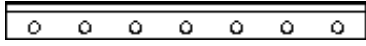
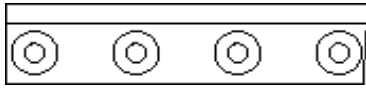
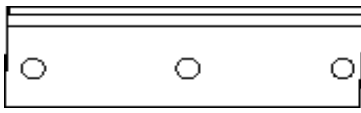
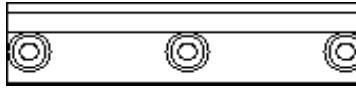
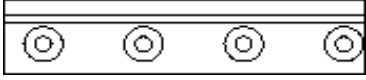
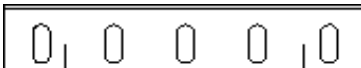
CONAIR	904 609.6-87.5-28 CON	609.6 x 87.5 x 28	
CUMBERLAND	904 206.4-97.6-30.2 CUM	206.4 x 97.6 x 30.2	
CUMBERLAND	904 256.9-84.1-12.7 CUM	256.9 x 84.1 x 12.7	
CUMBERLAND	904 295.3-34.9-6.4 CUM	295.3 x 34.9 x 6.4	
CUMBERLAND	904 301.6-73-12.7 CUM	301.6 x 73 x 12.7	
CUMBERLAND	904 357.2-111.1-19.1 CUM	357.2 x 111.1 x 19.1	
CUMBERLAND	904 447.7-111.1-28.6 CUM	447.7 x 111.1 x 28.6	
CUMBERLAND	904 471.5-109.7-28.6 CUM	471.5 x 109.7 x 28.6	
CUMBERLAND	904 474.6-96.9-22.2 CUM	474.6 x 96.9 x 22.2	

904 Nože na plast -For Plastics - Fur Kunststoff - Nože do plastiku

CUMBERLAND **904 506.4-57.2-15.9 CUM** **506.4 x 57.2 x 15.9** 

CUMBERLAND **904 507.2-85.7-22.2 CUM** **507.2 x 85.7 x 22.2** 

CUMBERLAND **904 508.8-111.1-19.1 CUM** **508.8 x 111.1 x 19.1** 

CUMBERLAND **904 547.7-76.2-19.1 CUM** **547.7 x 76.2 x 19.1** 

CUMBERLAND **904 551.9-96.8-22.2 CUM** **551.9 x 96.8 x 22.2** 



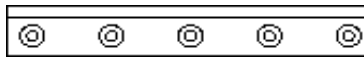

CUMBERLAND **904 617.5-84.1-15.8 CUM** **617.5 x 84.1 x 15.8** 

CUMBERLAND **904 635-109.7-28.6 CUM** **635 x 109.7 x 28.6** 



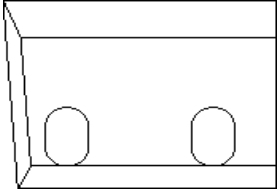
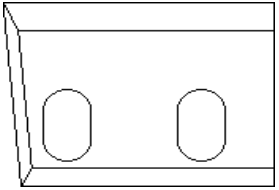

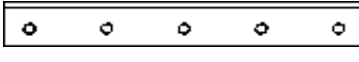
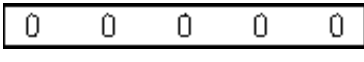
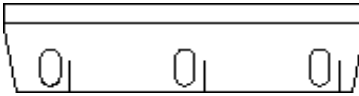
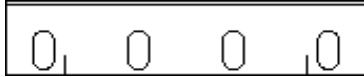
CUMBERLAND **904 638.2-97.5-22.2 CUM** **638.2 x 97.5 x 22.2** 

CUMBERLAND **904 711.2-110.2-19.1 CUM** **711.2 x 110.2 x 19.1** 



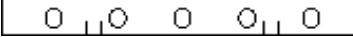
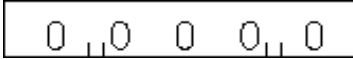
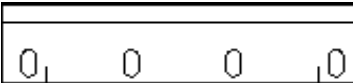
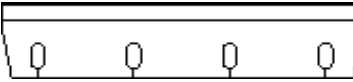
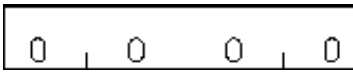
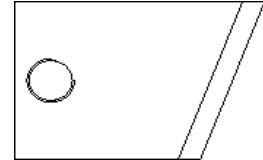

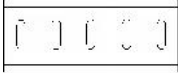

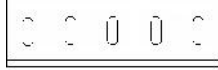

904 Nože na plast -For Plastics - Fur Kunststoff - Nože do plastiku

DIPRE	904 75-58-8 DIP	75 x 58 x 8	
DIPRE	904 101.5-78-10 DIP	101.5 x 78 x 10	
DIPRE	904 395.5-70-10 DIP	395.5 x 70 x 10	
DIPRE	904 402-69.5-13	402 x 69.5 x 13	
DIPRE	904 502.5-70-10 DIP	502.5 x 70 x 10	
DIPRE	904 509-69.5-13 DIP	509 x 69.5 x 13	
ENGIN PLAST	904 245-66.5-12 ENG	245 x 66.5 x 12	
ENGIN PLAST	904 248-57-11 ENG	248 x 57 x 11	
ENGIN PLAST	904 299-83-20 ENG	299 x 83 x 20	

904 Nože na plast -For Plastics - Fur Kunststoff - Nože do plastiku

ENGIN PLAST	904 338-48-11 ENG	338 x 48 x 11	
ENGIN PLAST	904 338-58-11 ENG	338 x 58 x 11	
ENGIN PLAST	904 379-93-25 ENG	379 x 93 x 25	
ENGIN PLAST	904 393.5-92-19 ENG	393.5 x 92 x 19	
ENGIN PLAST	904 398-78-20 ENG	398 x 78 x 20	
EREMA	904 40-58-4 ERE	40 x 58 x 4	
EREMA	904 130-35-3 ERE	130 x 35 x 3	
EUROTOOLS	901 350-85-15 EUR P	350 X 85 X 15	
EUROTOOLS	901 350-85-15 EUR P	350 X 85 X 15	

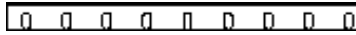

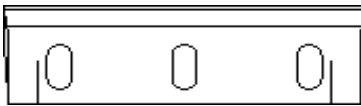
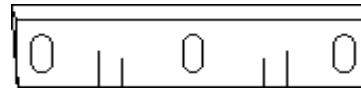
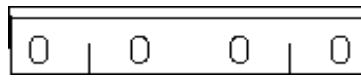
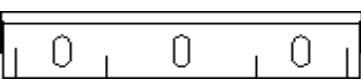
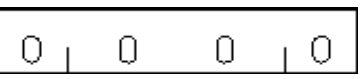
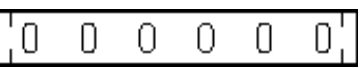
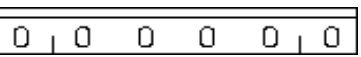
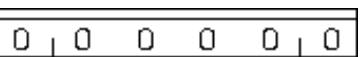
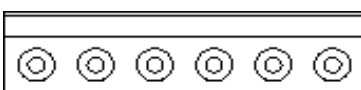

904 Nože na plast -For Plastics - Fur Kunststoff - Nože do plastiku

EUROTOOLS	901 430-85-18 EUR P	430 X 85 X 18	
EUROTOOLS	901 434-85-18 EUR P	434 X 85 X 18	
FEARNEHOUGH	904 195-56-28 FEA	195 x 56 x 28	
FOREMOST	904 457.2-49.2-30.1 FOR	457.2 x 49.2 x 30.1	
FOREMOST	904 457.2-57.2-15.9 FOR	457.2 x 57.2 x 15.9	
FOREMOST	904 609.6-76.2-25.4 FOR	609.6 x 76.2 x 25.4	
FOREMOST	904 711.2-57.2-15.9 FOR	711.2 x 57.2 x 15.9	
FOREMOST	904 914.4-73-25.4 FOR	914.4 x 73 x 25.4	
GRANUTEC	904 606.4-92.1-15.9 GRA	606.4 x 92.1 x 15.9	



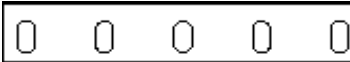
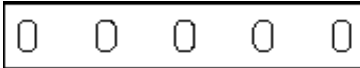
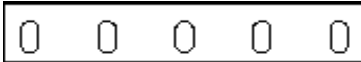

904 Nože na plast -For Plastics - Fur Kunststoff - Nože do plastiku

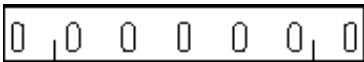
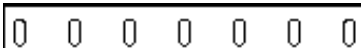
HERBOLD	904 320-100-22 HER	320 x 100 x 22	
HERBOLD	904 385-100-22 HER	385 x 100 x 22	
HERBOLD	904 470-100-22 HER	470 x 100 x 22	
HERBOLD	904 485-100-22 HER	485 x 100 x 22	
HERBOLD	904 488-100-22 HER	488 x 100 x 22	
HERBOLD	904 595-100-22 HER	595 x 100 x 22	
HERBOLD	904 700-100-28 HER	700 x 100 x 28	
HERBOLD	904 790-85-16 HER	790 x 85 x 16	
NELMOR	904 241.3-60.3-11.1 NEL	241.3 x 60.3 x 11.1	

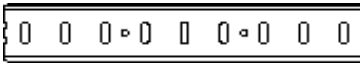
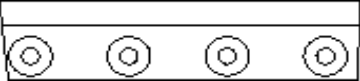

904 Nože na plast -For Plastics - Fur Kunststoff - Nože do plastiku

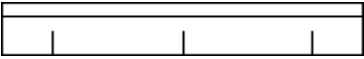
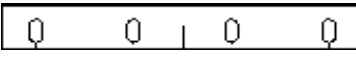
NELMOR	904 253.2-47.6-9.5 NEL	253.2 x 47.6 x 9.5	
NELMOR	904 368.3-92.1-15.9 NEL	368.3 x 92.1 x 15.9	
NELMOR	904 373.8-69.9-15.9 NEL	373.8 x 69.9 x 15.9	
NELMOR	904 373.8-81.1-15.9 NEL	373.8 x 81.1 x 15.9	
NELMOR	904 380.2-69.9-16 NEL	380.2 x 69.9 x 16	
NELMOR	904 454-95.3-19.1 NEL	454 x 95.3 x 19.1	
NELMOR	904 557.2-101.6-25.4 NEL	557.2 x 101.6 x 25.4	
NELMOR	904 558.8-93.8-19 NEL	558.8 x 93.8 x 19	
NELMOR	904 608-88.9-19.1 NEL	608 x 88.9 x 19.1	

904 Nože na plast -For Plastics - Fur Kunststoff - Nože do plastiku

PIERRET	904 640-120-11.1 PIE	640 x 120 x 11.1	
POLYMER	904 292.1-74.6-14.3 POL	292.1 x 74.6 x 14.3	
POLYMER	904 604.8-64.4-14.3 POL	604.8 x 64.4 x 14.3	
PREVIERO	904 514-88-24 PRE	514 x 88 x 24	
PREVIERO	904 600-98-24 PRE	600 x 98 x 24	
PREVIERO	904 614-88-24 PRE	614 x 88 x 24	
PREVIERO	904 800-98-24 PRE	800 x 98 x 24	

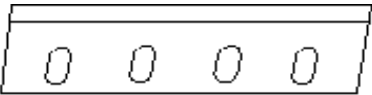
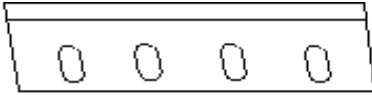
905 Nože na trávu - Grass Knives - Gras Messer - Nože

MANUFACTURER	CODE	SIZE mm	PLAN
EUROKNIVES	905 350-110-9 EUR L	350 X 110 X 9	
EUROKNIVES	905 350-110-9 EUR R	350 X 110 X 9	
EUROKNIVES	905 955-50-22 EUR	955 X 50 X 22	
EUROKNIVES	905 989-50-22 EUR	989 X 50 X 22	

Magnetický zverák MagVise

Revolučný spôsob upínania pri obrábani

Vhodný na frézy a CNC horizontálne a vertikálne obrábacie centrá.

(obrábanie z 5tich strán)

Permanentný magnetický upínací blok



ECB



Vhodné pre obrábanie stredných a veľkých obrobkov

Elektropermanentná magnetická upínacia platňa

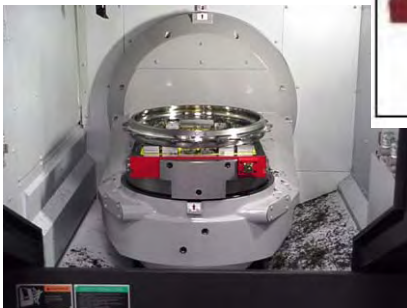

EPM

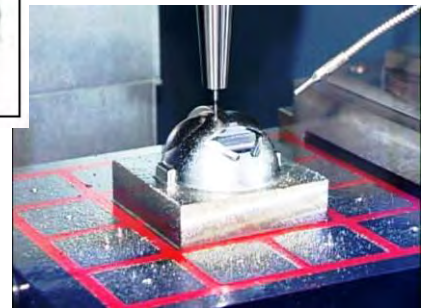
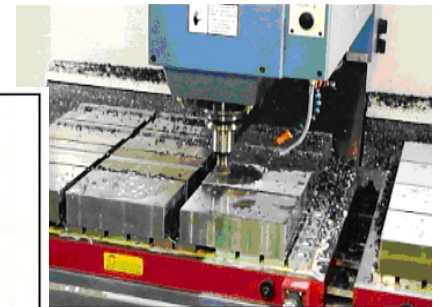

Vhodné pre obrábanie malých a stredných obrobkov

Permanentný magnetický upínací blok ECB

Obrábanie stredných & veľkých obrobkov
(obrábanie z 5tich strán)



Štandardné príslušenstvo:

- Rúčka 1 sada
- Pólový nástavec 1 sada
- Ukončovacia platňa 1 sada
- Doraz 2 sady
- Spojovací konektor 1 sada
(len pre ECB-CB)

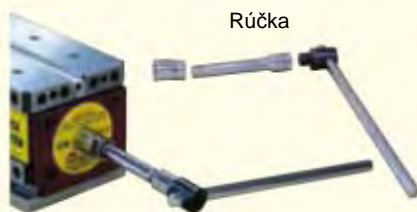

ECB-CA so spojovacím konektorom ECB-CB bez spojovacieho konektora

„zapnuté ON“

„vypnuté OFF“

Model. Č.	Prídržná Sila	Minimálna hrúbka obrobku	G mm	G = +0 - 0,03 mm	Výška H	H=+0,01 -0,01	Poznámka	Váha
ECB-210CA	2100 kg	Hrúbka 20 mm	115	Vyžaduje prefrézovať	134	Vyžaduje prefrézovať	-----	36 kg
ECB-210CB	2100 kg						So spojovacím konektorom	
ECB-120CA	1200 kg	Hrúbka 15 mm	94,5	Vyžaduje prefrézovať	108	Vyžaduje prefrézovať	-----	18 kg
ECB-120CB	1200 kg						So spojovacím konektorom	
ECB-075CA	750 kg	Hrúbka 10 mm	88	Vyžaduje prefrézovať	78	Vyžaduje prefrézovať	-----	9,5 kg
ECB-075CB	750 kg						So spojovacím konektorom	
ECB-050CA	500 kg	Hrúbka 10 mm	61	Vyžaduje prefrézovať	78	Vyžaduje prefrézovať	-----	7 kg
ECB-050CB	500 kg						So spojovacím konektorom	

Porovnanie upnutia v zveráku a v bloku ECB

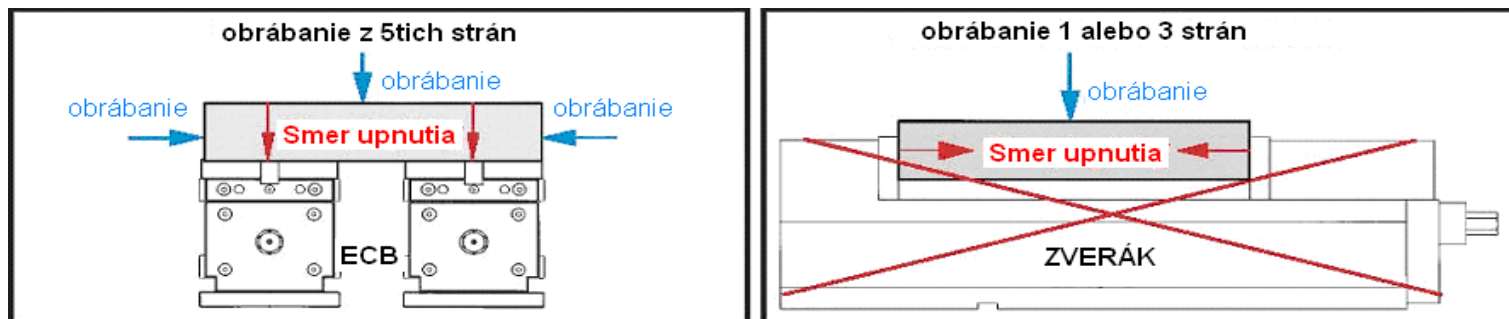

Charakteristika:

1. Nový model "Permanentného Magnetického Upínacieho Bloku" **ECB** predstavuje revolučný spôsob upínania obrobkov na CNC obrábacích centrách a frézach z rýchlym upínaním.
2. Nie je limitovaný umiestnením, počtom ani vzdialenosťou „Magnetických Upínacích Blokov“ podľa veľkosti obrobku.
3. **ECB** bloky sa dodávajú spolu s vymeniteľnými „pólovými nastavcami“. Tie môžu byť prefrézované/preblúsené tak, aby sme dosiahli 100% presnosť a rovnobežnosť obrobku s rovinou stroja po upnutí obrobku. Do pólových nastavcov môžeme taktiež rezať, vŕtať, závitovať alebo frézovať počas obrábania obrobkov. Pólové nastavce môžu byť viacnásobne použité na konkrétne obrobky, sú ľahko vyrobiteľné priamo používateľom Magnetických Upínacích Blokov .
4. Dva možné cykly obrábania zlepšujú celkovú efektívnosť obrábania a dosiahnete potrebnú presnosť obrábania.

Možnosti použitia:

1. Vhodné pre obrábanie stredných a veľkých obrobkov na frézach a CNC centrách
2. Minimálna veľkosť obrobku je minimálne plocha dvoch "Magnetických Upínacích Blokov ".
3. " Permanentné Magnetické Upínacie Bloky " nie sú vhodné na malé obrobky

Poznámky:

1. Vždy sa uistite že prepínač je v polohe "ON" pred začatím obrábania.
2. " Permanentné Magnetické Upínacie Bloky " nie sú vhodné na nemagnetické materiály ako mosadz, meď, hliník, atď.
3. Princíp " Permanentných Magnetických Upínacích Blokov " je vo využití magnetizmu medzi S a J pólmi, prosím vždy uložte obrobok medzi póly S a J (v strede vrchnej časti upínacieho rozsahu)

Model. Č.		ECB 210	ECB 120	ECB 075	ECB 050
Bočná vzdialenosť	Minimum	100 mm	80 mm	25 mm	25 mm
	Maximum	1000 mm	600 mm	400 mm	400 mm
Vzdialenosť prednej a zadnej strany	Minimum	70 mm	40 mm	40 mm	40 mm
	Maximum	180 mm	140 mm	140 mm	140 mm
		Štandardný spojovací konektor			
		500 mm	300 mm	200 mm	200 mm
		Špeciálny spojovací konektor			
Minimálna hrúbka obrobku		20 mm	15 mm	10 mm	10 mm

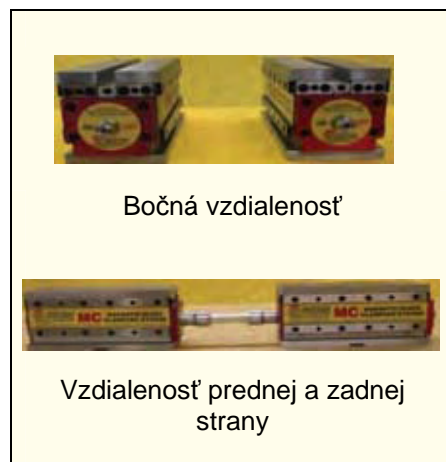

Príklady použitia

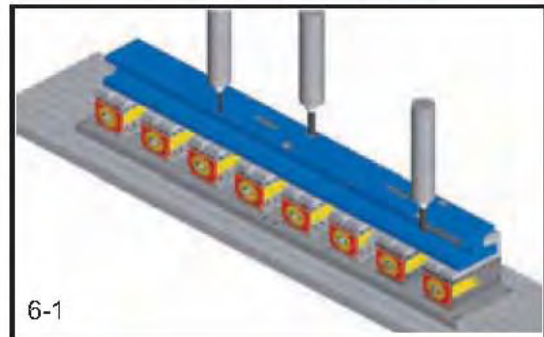
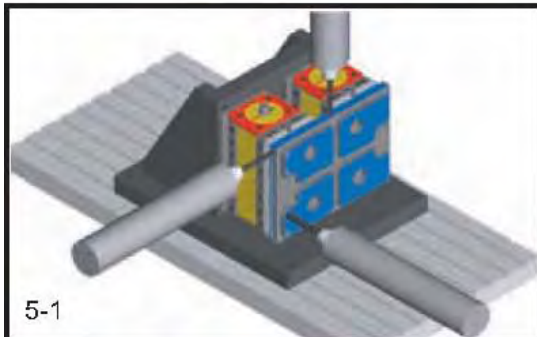
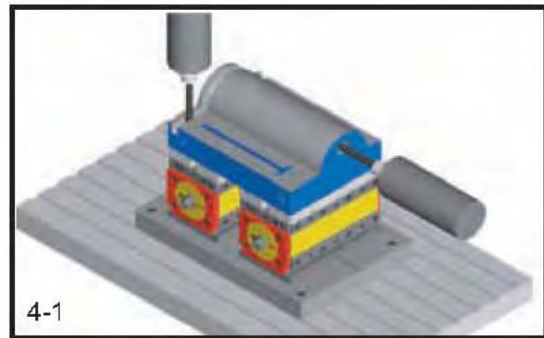
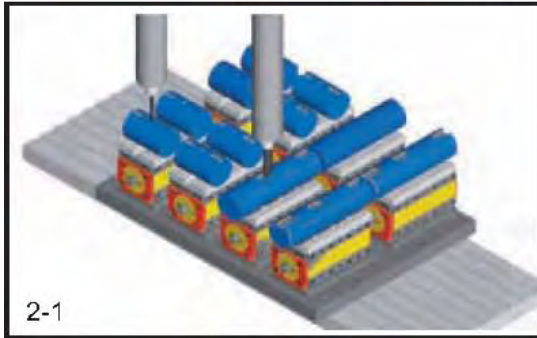
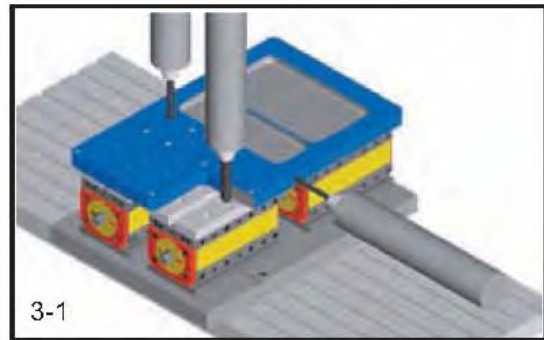
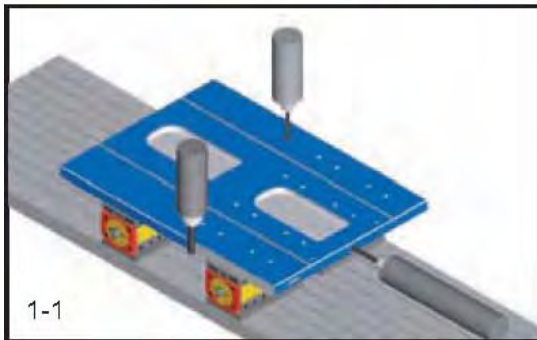

Elektropermanentná magnetická upínacia platňa EEPM

Obrábanie stredných & veľkých obrobkov
(obrábanie z 5tich strán)

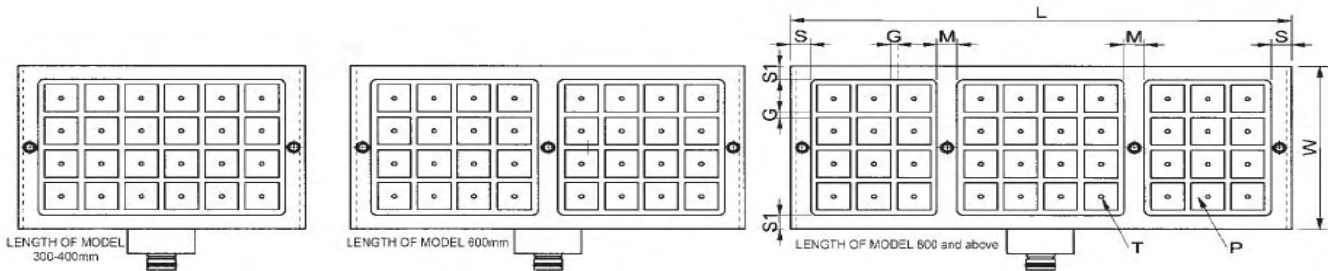

Model. Č.	Rozmery							Medzera G	Nástavec P	Počet nástavcov	Napätie	Prúd A	Váha Platne kg	Riadiaca jednotka	Váha riadiacej jednotky
	W	L	S	S1	M	T	výška								
EEPM-2540W	240	430			---				18		35	50	EEPM-C1		
EEPM-2560W	240	590			30				24		30	69	EEPM-C1	6 kgs	
EEPM-2580W	240	810			30				33		35	92	EEPM-C1		
EEPM-2590W	240	870			30				36		20	98	EEPM-C2	6 kgs	
EEPM-25100W	240	990			30				42		35	111	EEPM-C2		
EEPM-3030W	300	310							16		20	44	EEPM-C1		
EEPM-3040W	300	430			---				24		30	61	EEPM-C1	6 kg	
EEPM-3060W	300	590			30				32		35	82	EEPM-C1		
EEPM-3080W	300	810			30				44		35	116	EEPM-C2		
EEPM-3090W	300	870			30				48		20	123	EEPM-C2		
EEPM-30100W	300	990	30	25	30	M8	70	10	56	50x50	30	138	EEPM-C2	6 kgs	
EEPM-4040W	420	430							36		20	84	EEPM-C2		
EEPM-4050W	430	480			---				42		35	95	EEPM-C2		
EEPM-4060W	420	590			30				48		30	116	EEPM-C2		
EEPM-4080W	420	810			30				66		30	159	EEPM-C2	9 kgs	
EEPM-4090W	420	870			30				72		20	169	EEPM-C4		
EEPM-40100W	420	990			30				84		35	193	EEPM-C4	6 kgs	
EEPM-5060W	480	590			30				56		30	129	EEPM-C2		
EEPM-5080W	480	810			30				77		20	185	EEPM-C4		
EEPM-5090W	480	870			30				84		20	196	EEPM-C4		
EEPM-50100W	480	990			30				98		20	219	EEPM-C4		
EEPM-6060W	600	590			30				72		20	165	EEPM-C4	9 kgs	
EEPM-6080W	600	810			30				99		25	215	EEPM-C4		
EEPM-6090W	600	870			30				108		25	240	EEPM-C4		
EEPM-60100W	600	990			30				126		25	274	EEPM-C4		
EEPM-8080W	755	810			30				121		25	271	EEPM-C4		

Charakteristika:

1. Super upínacia magnetická sila 1000 kg/100 cm².
2. Zapnutie ON a vypnutie OFF za 2 sekundy. Nie je potrebná elektrická energia na udržanie magnetického upínania zapnutého ON. Bezpečné v prípade vypnutia prívodu elektrickej energie.
3. Keďže nie je potrebný prívod elektrickej energie , obrobok môže byť upnutý neobmedzene dlhý čas bez rizika zohriatia ktoré by mohlo spôsobiť rozmerové zmeny a deformácie.
4. Umožňuje 5 osé obrábanie, nerušený pohyb nástroja počas obrábania. Obrobenie výrobku pri jednom upnutí umožňuje dosiahnuť vysokú presnosť a zlepšuje výrazne výkonnosť a efektývnosť.
5. Jednoduché a rýchle upínanie obrobku skraca celkový čas výroby.



Možnosti použitia:

1. Vhodné pre obrábanie stredných a malých obrobkov na frézach a CNC centrách, taktiež na nerovné obrobky.
2. Taktiež vhodné na vŕtanie a jemné obrábanie malých výrobkov.
3. Minimálna veľkosť obrobku je plocha štyroch pólových nástavcov aby sa dosiahla maximálna sila upnutia.
4. Minimálna hrúbka obrobku je 10 mm
5. EEPM platne sa ľahko integrujú do systémov s paletovými výmenníkmi.



Obrábanie z 5tich strán

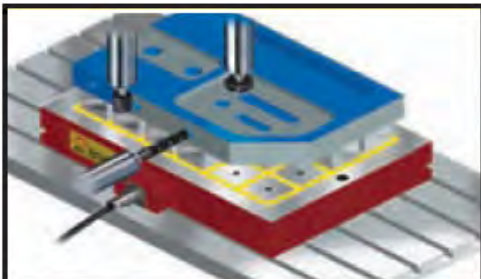

Obrábanie kruhových prierezov

Obrábanie viacerých kusov z 5tich strán

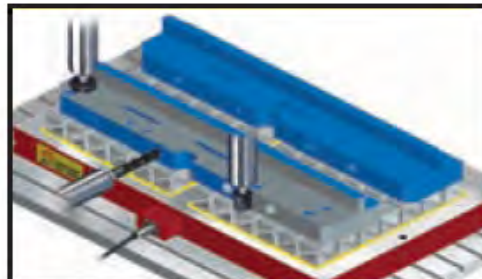

Výroba 3D výrobkov

Výroba foriem

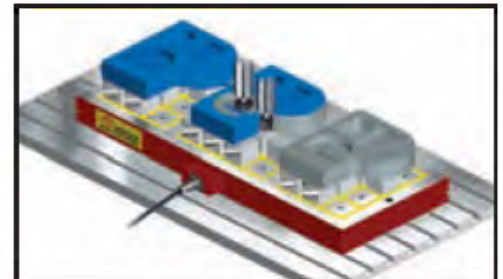

Obrábanie odliadkov

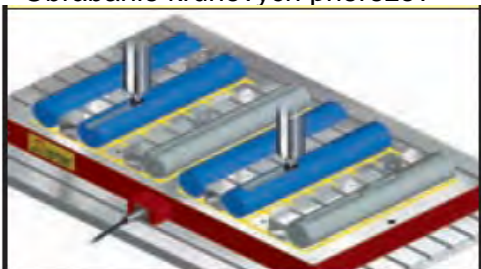

Obrábanie viacerých kusov

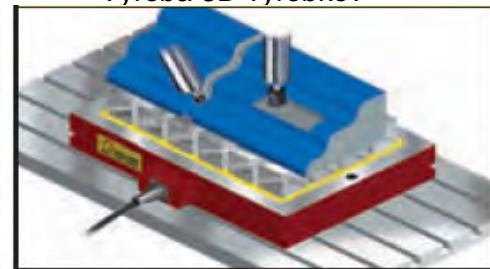

Obrábanie na paletových výmenníkoch



Obrábanie povrchov

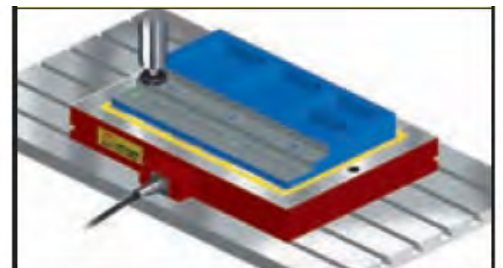
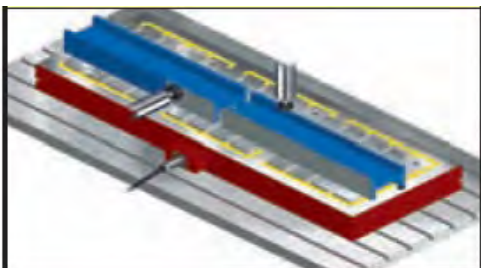

Elektropermanentná magnetická upínacia platňa EEPM

Obrábanie stredných &
veľkých obrobkov
(obrábanie z 5tich strán)

Nový model „ Stolovej otočnej EEPM upínacej platne „ vyvinutý na klasické frézy môžete využívať na obrábanie z 5tich strán.



Verikálny model EEPM platne na horizontálne vyvrtávačky (na objednávku)



Špeciálny model EEPM platne na obrábanie extra dlhých kusov na frézach a brúskach



Spodná platňa Indukčného bloku na rýchlu výmenu rôznych obrobkov

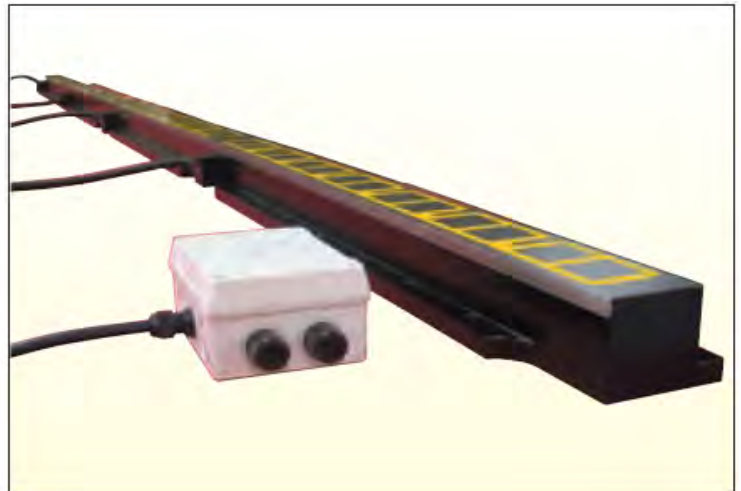

EEPM platňa použitá na 5 osom obrábacom CNC centre

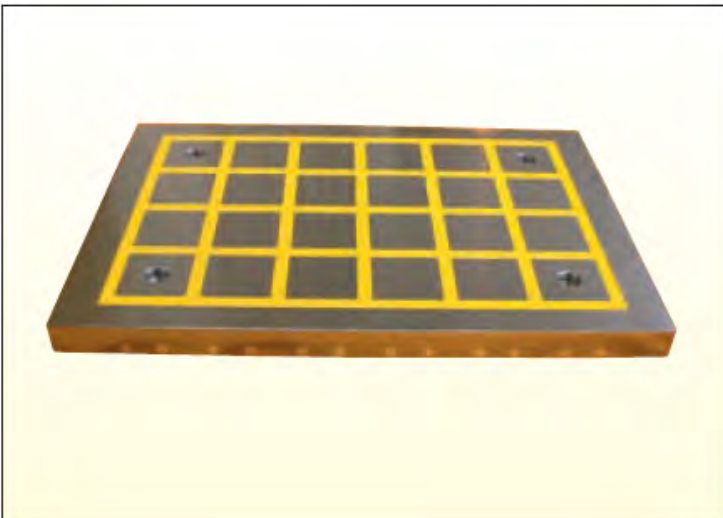

Príklady použitia

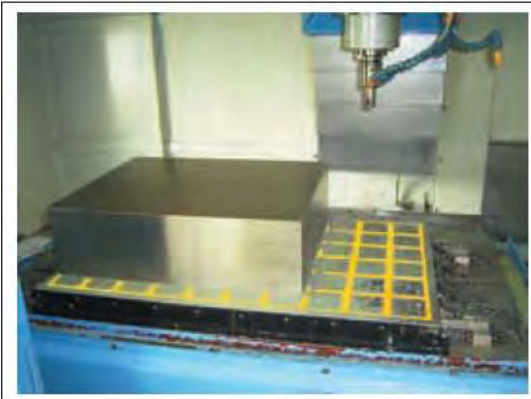

Charakteristika:

1. Nikdy nezmení presnosť pracovnej plochy pri zapnutí a vypnutí ON a OFF
2. Vodotesné prevedenie
3. Model EHMT 3060B a vyššie majú dvojité prepínač

Možnosti použitia:

1. Vhodné pre obrábanie tenkých a malých obrobkov
2. Najpoužívanejšie na vysokorychlostné obrábacie centrá

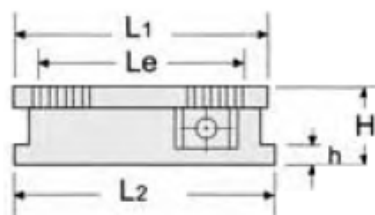
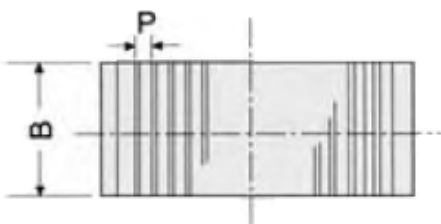

Model. Č.	Rozmery	Vrchná platňa			Medzera pólov P	Spodná platňa		Výška H	Váha kg	
		B	L1	Le		L2	h			
EHMT - 1018B	100 x 175	100	175	128	11.2 (1.6+2+1.6+6)	195	13	65	8	
EHMT - 1030B	100 x 300		300	246		320			13	13
EHMT - 1325B	125 x 250		125	250		196			270	14
EHMT - 1515B	150 x 150	150	150	106		170			10	
EHMT - 1530B	150 x 300		300	246		320			19	
EHMT - 1535B	150 x 350		350	296		370			22	
EHMT - 1540B	150 x 400		400	346		420		26		
EHMT - 1545B	150 x 450	450	396	470		29				
EHMT - 2020B	200 x 200	200	200	150		220		17		
EHMT - 2030B	200 x 300		300	246		320		26		
EHMT - 2040B	200 x 400		400	346		420		34		
EHMT - 2550B	250 x 500		450	390		470		38		
EHMT - 2050B	200 x 500		500	446		520		43		
EHMT - 2060B	200 x 600	600	446	620		51				
EHMT - 2525B	250 x 250	250	250	196		270		27		
EHMT - 2530B	250 x 300		300	246		320		32		
EHMT - 2540B	250 x 400		400	346		420		43		
EHMT - 3030B	300 x 300		300	246		320		44		
EHMT - 3040B	300 x 400	300	400	346	420	59				
EHMT - 3050B	300 x 500		500	446	520	74				
EHMT - 3060B	300 x 600		600	543	620	88				
EHMT - 3090B	300 x 900		900	834	920	132				
EHMT - 4040B	400 x 400	400	400	346	420	79				
EHMT - 4050B	400 x 500		500	446	520	98				
EHMT - 4060B	400 x 600		600	543	620	117				
EHMT - 4080B	400 x 800		800	733	820	156				
EHMT - 40100B	400 x 1000		1000	935	1020	195				

Nové super bezpečné zdvíhacie magnety uľahčujú manipuláciu s bremenami

Charakteristika:

1. Super silné neodým-železo-bórové (NdFeB) magnety bez potreby prívodu el. energie
2. Na maximálnu bezpečnosť udržia až 3,5 x viac ako je ich uvádzaná nosnosť
3. Nahrádzajú nebezpečné zdvíhacie laná a pásy
4. Bez potreby akejkoľvek údržby, odolné voči prachu a vode

Možnosti použitia:

1. Vhodné do skladov ocele
2. Rýchle a bezpečné nakladanie a vykladanie tovaru
3. Jednoduchá manipulácia s obrobkami



ELM-100



ELM-300



ELM-600



ELM-1000



ELM-2000



ELM-3000



Zdvíhaný materiál	Oceľové platne		Kruhovú oceľ		Maximálna dĺžka
	Zdvíhacia kapacita	Minimálna hrúbka	Zdvíhacia kapacita	Maximálny priemer	
ELM-100	100 kg	15 mm	45 kg	150 mm	1000 mm
ELM-300	300 kg	25 mm	135 kg	250 mm	1500 mm
ELM-600	600 kg	30 mm	270 kg	350 mm	2000 mm
ELM-1000	1000 kg	40 mm	450 kg	450 mm	2500 mm
ELM-2000	2000 kg	55 mm	900 kg	550 mm	3000 mm
ELM-3000	3000 kg	60 mm	1350 kg	650 mm	3500 mm



NORTH HEMISPHERE



WEST HEMISPHERE



EAST HEMISPHERE



SOUTH HEMISPHERE